

Are you sure you don't need a fuse?

Safe and reliable! HINODE PROTECT FUSE



HINODE PROTECT FUSES,
highly trust worthy and with a proven track record,
are used in nearly every industry.

Today's power devices are generally equipped with various security features, and their safety has improved greatly. However, extraordinary, unexpected "accidents" do happen from time to time.

All means of protection adopted on design may become futile in cases such as:

- Errors in assembly work
- Contamination with a foreign substance
- Damage to semiconductors by disturbances such as heat or shock

Before such accidents affect other chips or equipment, HINODE PROTECT FUSE will safely block off equipment as the last line of protection.

What is the HINODE PROTECT FUSE?

HINODE PROTECT FUSE is a fast-acting fuse that blocks off equipment in a few microseconds even in cases of short-circuit accidents that ordinary fuses (slow-blow fuses) and circuit breakers cannot protect against.

FEATURES OF HINODE PROTECT FUSE

- Safe and reliable: Fast-acting fuse that can block off even direct-current
- Small and compact: Compared with a slow-blow fuse and a circuit breaker (see photo)
- Applicable to high voltage: Up to 1500V*
- Large capacity: Current breaking capacity of up to 100kA*

* Specifications vary depending on the product; refer to the specifications of each product for details.

Applications of HINODE PROTECT FUSE

HINODE PROTECT FUSE is widely used for general power electric products (approximately 1kW), including:

- Inverter motor drivers
- Servo drivers
- Direct-Current power sources
- Alternating-Current variable power sources
- Uninterruptible power supplies (UPSs)

Q : Is HINODE PROTECT FUSE easy to break if it is so quick to cut off?

A : No, it's not. Conversely, around the rated amperage, our fuse is less likely to break than a slow-blow fuse (refer to chart below).

Comparison between PROTECT FUSE and a slow-blow fuse
Curve of Fusing Time vs. Current

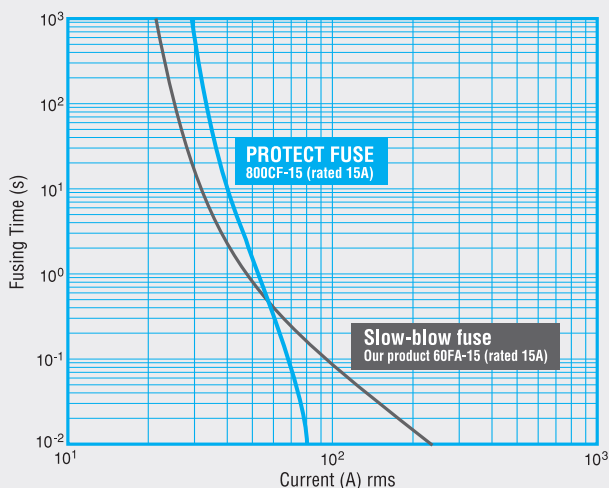

PURPOSE AND APPLICATIONS

When a short circuit occurs, an overcurrent*¹ greatly exceeding the rated amperage flows in a circuit. This causes abnormal heat generation on the wiring pattern and parts and may lead to an accident such as ignition, fumes, or explosion. When a short-circuit current damages a component,

it is generally not easy to locate, so restoration of functionality tends to take a long time. Our fuses will help minimize such accidents and, in the case of an accident, will help you work efficiently for restoring the functionality.*² The following are applications of our fuses:

Protecting semiconductors (diodes, thyristors, etc.)

- Purpose: To protect semiconductors from the overcurrent when a load circuit shorts out or to prevent secondary damage when a semiconductor itself is broken down.*³
- Applications: Thyristor stacks, electric power regulators, electric furnaces (equipment with heater controls by SSR, etc.), DC stabilized power supplies, and, generally, modules with a power device.

Protection from a short circuit caused by deterioration of components

- Purpose: To prevent secondary damage from an internal short circuit caused by a decrease of insulation resistance that is the result of deterioration of a condenser.
- Applications: Capacitors and circuits using smoothing condensers (such as power supply circuits).

Protection from a short-circuit mode (arm short circuit) in an inverter circuit

- Purpose: To prevent secondary damage of an arm short circuit caused by destruction of a transistor or a diode, a breakdown of a control circuit and/or a drive circuit, or a malfunction by noise.
- Applications: Bridge circuits in equipment (motor drives, air conditioners, UPSs, etc.) with an insulated gate bipolar transistor (IGBT) or other related semiconductors.

Protection from any other short circuits such as output short circuits, earth short circuits, and battery short circuits















- Purpose: To prevent secondary damage of an output short circuit or an earth short circuit caused by miswiring, an insulation defect of a load, etc. To protect between devices or between units. To prevent secondary damage caused by a two-polar-plate short circuit of a battery.
- Applications: All industrial equipment such as battery-powered machinery (forklifts, golf carts, UPSs, etc.), control boards, instruments to manufacture semiconductors, and so on.

*¹ Short current depends on the capacity of the circuit, but it could be a large current above a few thousand amperes. Most of our products have a current-breaking capacity of over 10kA at the maximum and are able safely to block off such current.

*² Because of cut-off by a fuse, it is easy to locate the troubled circuit and also to minimize damage to other devices.

*³ The breakdown of semiconductors is caused by diode destruction, gate destruction, temperature destruction, avalanche destruction, oscillation destruction, and so on.

CONTENTS

Series Name	Voltage	Electric Current	Cylinder Size (Estimated)	Installation Method	Page	RoHS Compliant	Standard Approved * ⁴
COMPACT FAST ACTING FUSES							
250SF/250SFK	250V	4~25A	φ6×31	Clipped / Board Soldered	P6~7	Conforming	
500SF/500SFK	500V	4~20A	φ6×31	Clipped / Board Soldered	P6~7	Conforming	
400KH/400KHK	400V	5~60A	φ10×26	Clipped / Board Soldered	P8~9	Conforming	
660CF/KH/KHK	660V	5~60A	φ10×38	Clipped / Screwed / Board Soldered	P10~11	Conforming	 
700CF/800CF/1000CF	700V/1000V	5~40A	φ15×51~	Clipped	P12~14	Conforming	
CYLINDRICAL FAST ACTING FUSES — SCREWING TYPES							
250GH/350GH	250V/350V	16~800A	φ17×25~	Screwed	P15~17	Conforming	 
660GH	660V	16~710A	φ17×46~	Screwed	P18~19	Conforming	 
1000GH	1000V	16~630A	φ17×66~	Screwed	P20~21	Conforming	
SQUARE FAST ACTING FUSES							
600SPF	600V	80~1750A	□30×43×53~	Screwed	P22~23	Conforming * ⁵	
1000SPF	1000V	80~1500A	□30×43×73~	Screwed	P24~25	Conforming * ⁵	
1500SPF	1500V	80~1200A	□30×43×103~	Screwed	P26~27	Conforming * ⁵	
Options							
FUSE HOLDERS					P28~29	Conforming	
MICROSWITCHES					P29	Conforming	
PROTECT FUSE USER'S GUIDE							

*⁴ It does not mean that the standard approved applies to every rated voltage. Refer to the product information page of each fuse for details.

*⁵ Not conforming to Chinese RoHS.

The information for products not listed in this catalog can be found on our website.

QUESTIONS AND ANSWERS

I'd like to know which fuse to use.

Refer to page 30 of PROTECT FUSE USER'S GUIDE.
Fuses need to have two opposing functions: breaking performance (the lower the rated amperage against conduction current, the better) and durability (the higher the rated amperage against conduction current, the better). Select a fuse that strikes a good balance between those two according to your needs.

What should I do when all fuses seem to be unsuitable?

Do not hesitate to contact our office. The data of each fuse and the guidelines on how to choose them listed in this catalog have margins for simplification. We are ready to provide you with more detailed information. Also, if you could provide us with details of your situation, we would be delighted to help you determine the best product for your needs.

I'd like to know the withstand voltage performance.

Refer to each rated voltage shown on the product pages. Select a fuse with a larger rated frequency than the circuit voltage (for DC, voltage after rectification) on the short circuit expected in case of an accident. Take the following points into consideration:

- Keep in mind that rated voltage of a fuse differs between AC and DC.
- For DC, available voltage changes according to the time constant (L/R) on the short circuit. Refer to the chart titled "Application to direct-current circuit" on each product page.
- Depending on the standard observed (UL standard, CCC standard, etc.), the rated voltage may change. Be aware that the fuse may not be regarded as an approved fuse when used in a circuit exceeding the rated voltage.
- Block-off can be achieved with a fuse that you select by following the above instructions. However, adopting a fuse with more voltage as leeway will enable you to;
 - Cope with voltage fluctuation.
 - Shorten the breaking time (mentioned below).
 - Decrease the minimum breaking current.

I'd like to know the breaking performance.

- I'd like to know if the fuse can block off before the object under protection is damaged.
 - 1) If overcurrent time is approximately over 10ms
 - (a) Refer to the fusing characteristics curve. If the current (A) vs. time (s) curve of the fracture characteristics of the target object is positioned to the right of the fusing characteristics curve of the product, it means the fuse can block off before the object is damaged.
 - 2) If overcurrent time is approximately under 1ms
 - (a) Compensate the shutdown I^2t value of each fuse using "shutdown I^2t against the working voltage" chart.
 - (b) If the permissible I^2t value for the target object is available, compare the shutdown I^2t with it, and if the shutdown I^2t is smaller than the permissible I^2t value, it means the fuse can block off before the object is damaged.
 - (c) If only the damaging current vs. time curve of the target object is available, calculate its permissible I^2t value [= (damaging current)² × time] and compare in the same way as in (b).

For the area of (1), it appears to be protected by other protection equipment and/or current-limiting functions, and our fuses are often selected emphasizing protecting the area of (2). Also, even in cases that the shutdown I^2t is larger than permissible I^2t , our fuses are often used to prevent explosions, ignitions, and secondary damage.

- I'd like to know the current value that the fuse cannot block off.
 - Refer to the breaking capacity of each fuse. Electric current exceeding the value cannot be blocked off.
 - Refer to the minimum breaking current of each fuse. Electric current below this value cannot be blocked off. Despite fusing, block-off may not take place, possibly causing an accident. Therefore, take the following measures:
 - ◆ Using the current control function of the circuits of other protection devices, ensure that current does not flow in that area.
 - ◆ Use a fuse with a rated voltage above the circuit voltage to reduce the minimum breaking current.

I'd like to know the electric durability performance.

- I'd like to know the maximum magnitude (amperes) and the maximum rate of increase of overcurrent that a fuse can endure.
 - Read the value from the fusing characteristics curve of each fuse.
 - When an electric current larger than current range of a fusing characteristics curve flows, the value is calculated from the fusing I^2t value of each fuse.
[Fusing time = fusing I^2t value ÷ (short-circuit current value)²]
(The fusing time and electric current are effective for overcurrent only once. Once such an overcurrent flows, the fuse becomes easy to cut off. For more details, refer to the material about life expectancy).
- I'd like to know the life expectancy of the fuse against constant electric current and repetitive overcurrent.
 - Refer to separate materials for details.

I'd like to know an environmental resistance performance.

- Heat generation: Refer to the temperature characteristics chart of each fuse.
- Temperature characteristics: Refer to the chart titled "Compensation by ambient temperature."
- Other details on environmental resistance: Contact us for more information.

I'd like to purchase a PROTECT FUSE.

Consult your agent or our company directly any time. If you already know which fuse to purchase, ask for an estimate from our website (<http://www.hinodedenki.co.jp/>).

I'd like to ask for analysis of a cut-off fuse.

Consult your agent or our company any time.

*Characteristics of each fuse (fusing characteristics, I^2t value, etc.) indicated in this catalog are average values and may change according to its condition of use, its environmental condition, individual variability, and so on. Use sufficient margin when making a selection.

250SF/250SFK, 500SF/500SFK

FEATURES

- A 6-mm- ϕ fuse, which is the of the same size as a glass tube fuse, can be used to implement a current breaking capacity of 10kA at 500V
- Able to block off even DC
- UL approved for up to rated 20A (500SF/SFK)
- Space-efficient

RATING

• 250SF/SFK

Rated voltage and breaking capacity : 250V AC–10kA, 250V DC (L/R = 10ms)–10kA
 Minimum breaking current : 250V AC/DC– 4 times the rated amperage
 Maximum arc voltage: 500V

• 500SF/SFK

Rated voltage and breaking capacity : 500V AC–10kA, 500V DC (L/R = 2ms)–10kA
 Minimum breaking current : 500V AC/DC– 4 times the rated amperage
 Maximum arc voltage : 1000V



250SF/500SF

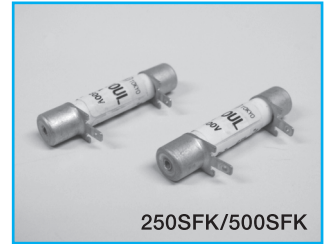

250SFK/500SFK

UL/cUL standard approved rating

Rated voltage and breaking capacity: Same as the standard rating.
 *250SF/SFK are not cUL approved.

CAUTION!

- Read “FOR SAFE USE” and “PROTECT FUSE USER’S GUIDE” at the back of this catalog before use.
- A small fuse may generate a relatively large amount of heat, so a fuse with sufficient capacity is recommended for long, continuous use.

Specifications 250SF/250SFK

500SF/500SFK

Type	Rated Amperage (A)	Fusing I ² t (A ² S)	Shutdown I ² t (A ² S) at AC250V 10KA	Power Loss (W)	Weight (g)	Fig	Standard
250SF-4UL 250SFK04UL	4	4	14	0.6 0.7	SF= 2.5	SF= Fig 1	UL
250SF-6UL 250SFK06UL	6	11	27	0.9 1.1			
250SF-10UL 250SFK10UL	10	25	60	1.6 1.7	SFK= 3.25	SFK= Fig 2	
250SF-16UL 250SFK16UL	16	55	120	3.5 3.2			
250SF-25 250SFK25	25	220	400	5.0 5.0			

Ta=25°C

Type	Rated Amperage (A)	Fusing I ² t (A ² S)	Shutdown I ² t (A ² S) at AC500V 10KA	Power Loss (W)	Weight (g)	Fig	Standard
500SF-4UL 500SFK04UL	4	4	29	0.6 0.7	SF= 2.5	SF= Fig 1	UL US
500SF-6UL 500SFK06UL	6	11	50	0.9 1.1			
500SF-10UL 500SFK10UL	10	25	110	1.6 1.7	SFK= 3.25	SFK= Fig 2	
500SF-16UL 500SFK16UL	16	55	230	3.5 3.2			
500SF-20UL 500SFK20UL	20	155	480	4.0 4.3			

Ta=25°C

Dimensions 250SF, 500SF <Fig.1>

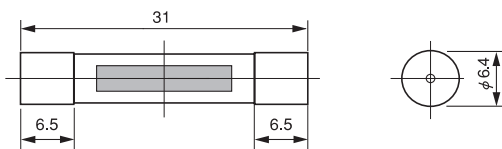

250SFK, 500SFK <Fig.2>

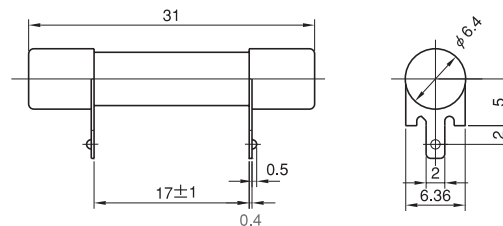

Fusing Characteristics 250SF/250SFK

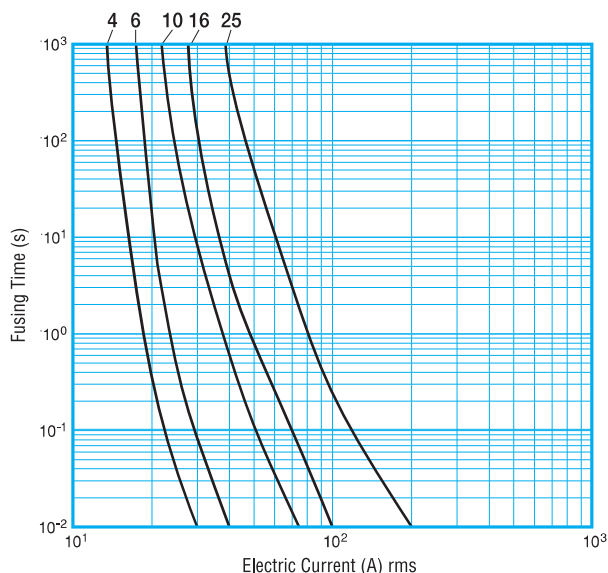

500SF/500SFK

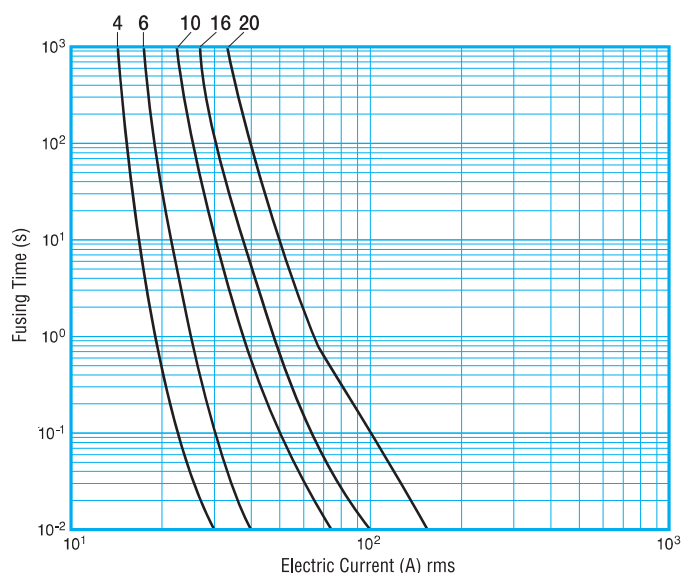

Temperature Rise 250SF/500SF

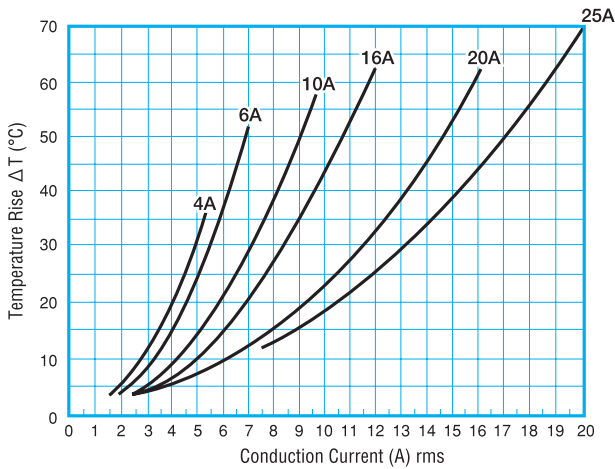

250SFK/500SFK

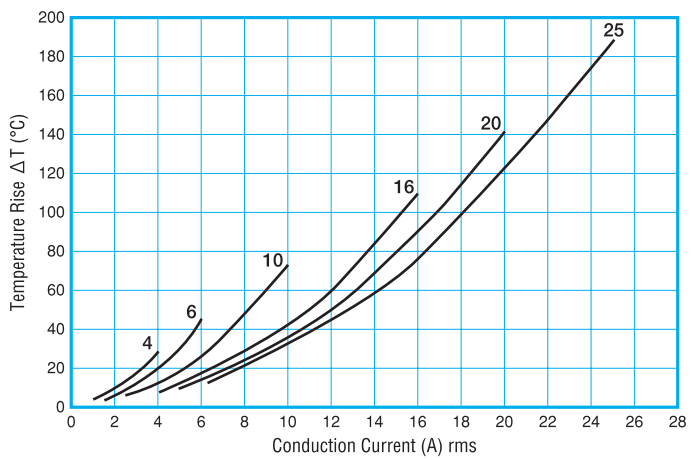

Power Loss 250SF/500SF

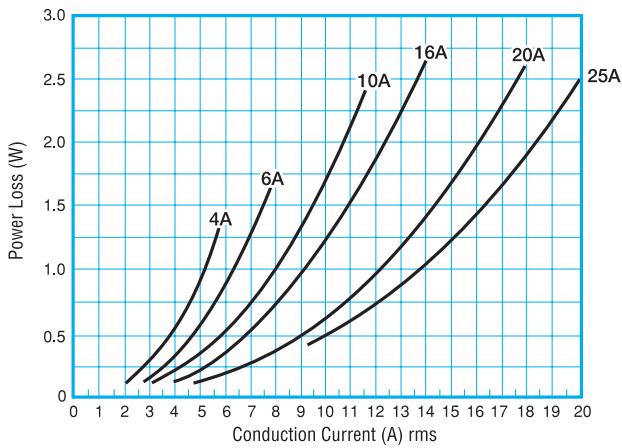

250SFK/500SFK

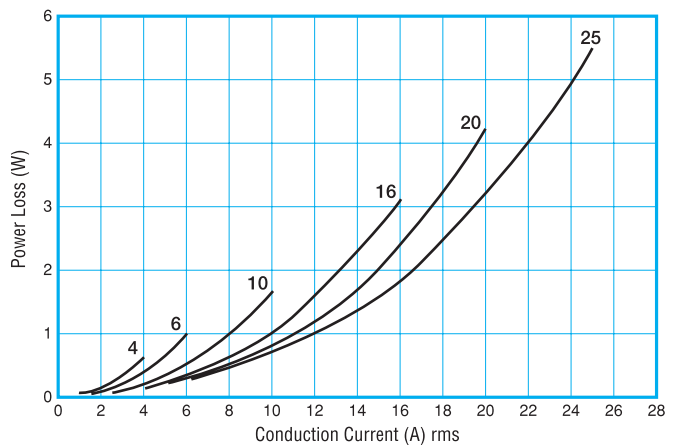

Shutdown I²t Against Working AC Voltage

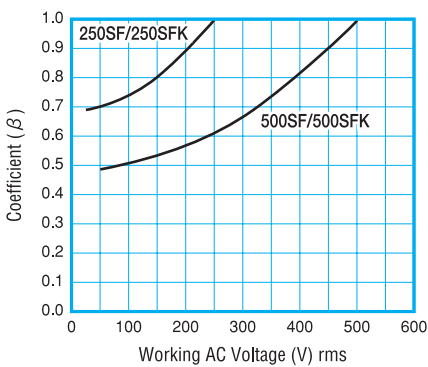

Current-Limiting Characteristics

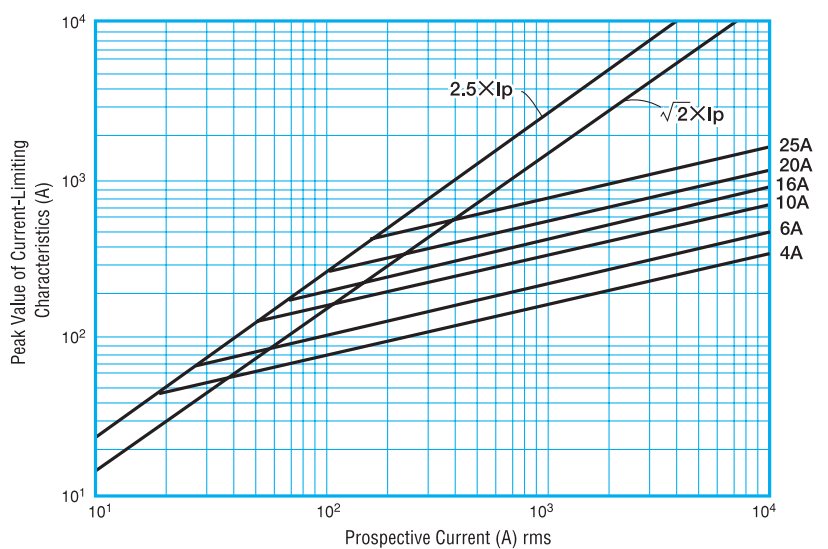

Application to Direct-Current Circuit

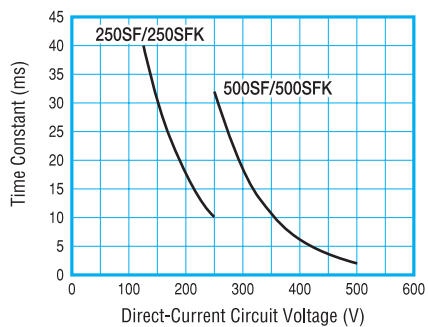

Power Loss and Temperature Characteristics

• Testing Conditions for Board-Soldered-Type Fuses

The power loss and the temperature characteristics are studied using an FR-4 board (one-side board) and a 35-μm-thick copper foil with a copper foil width of 0.5 mm/A depending on the rated amperage (e.g., 5 mm width for a product rated at 10A).

400KH/400KHK

FEATURES

- The full length is 26 mm (KHK), which is convenient to arrange on the board.
- Being extremely compact, it is compliant to 400V–50A class.
- Contribute to miniaturizing the equipment.
- Most suitable for small inverters, servos, UPSs, power supplies, etc.
- Two types are available for choice according to the installation method.

RATING

• Rating 5–30A

Rated voltage and breaking capacity : 400V AC – 10kA, 400V DC (L/R = 5ms)–10kA
 Minimum breaking current : 400V AC/DC – 4 times the rated amperage
 Maximum arc voltage : 800V

• Rating 35–60A

Rated voltage and breaking capacity : 400V AC–10kA, 400V DC (L/R = 2ms)–10kA
 Minimum breaking current : 400V AC – 5.3 times the rated amperage
 400V DC – 20 times the rated amperage
 360V DC – 8 times the rated amperage

Maximum arc voltage : 800V

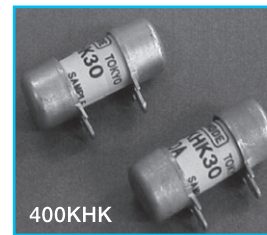
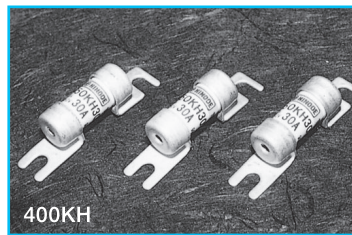

UL standard approved rating

When applying the standard to UL standard approved items, use the fuse in the following rating.

• Rating 5–30A

Rated voltage and breaking capacity : Same as the standard rating

• Rating 35–60A

Rated voltage and breaking capacity : 400V AC–10kA
 360V DC (L/R = 2ms)–10kA

CAUTION!

- Read “FOR SAFE USE” and “PROTECT FUSE USER’S GUIDE” at the back of this catalog before use.
- A small fuse may generate a relatively large amount of heat, so a fuse with sufficient capacity is recommended for a long, continuous use.
- Fusing indication function is not provided.

Specifications

Type	Rated Amperage (A)	Fusing I ² t (A ² S)	Shutdown I ² t (A ² S) at AC400V 10KA	Power Loss (W)	Weight (g)	Fig	Standard Approved	
400KH-5UL	5	2	30	0.5	10.5	KH= Fig 1	UL	
400KHK05UL				0.5				
400KH-10UL	10	6	70	1.0	10.5	KH= Fig 1		
400KHK10UL				1.1				
400KH-15UL	15	12	130	1.6	10.5	KH= Fig 1		
400KHK15UL				1.7				
400KH-20UL	20	25	280	2.3	10.5	KH= Fig 1		
400KHK20UL				2.9				
400KH-25UL	25	43	420	2.8	10.5	KH= Fig 1		
400KHK25UL				2.9				
400KH-30UL	30	67	700	2.8	8.5	KHK= Fig 2		UL
400KHK30UL				3.9				
400KH-35UL	35	99	1000	2.8	8.5	KHK= Fig 2		
400KHK35UL				5.2				
400KH-40UL	40	177	1600	3.3	8.5	KHK= Fig 2		
400KHK40UL				5.2				
400KH-50UL	50	264	2100	4.5	8.5	KHK= Fig 2		
400KHK50UL				6.9				
400KH-60UL	60	314	2300	5.4	8.5	KHK= Fig 2		
400KHK60UL				7.1				

Dimensions

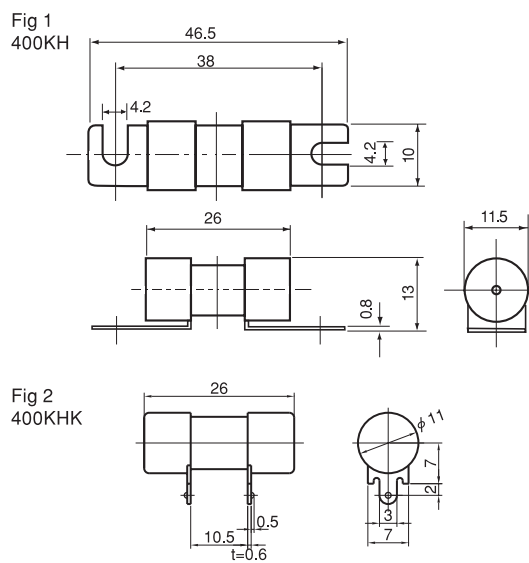

Fusing Characteristics

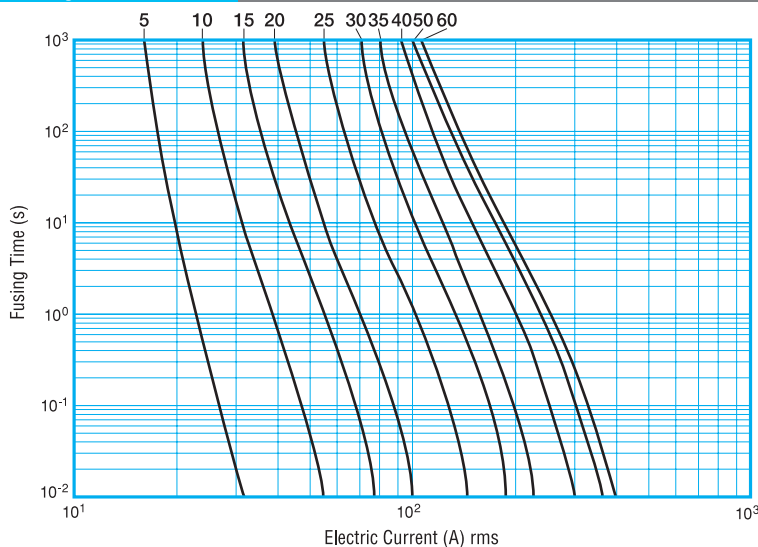

Current-Limiting Characteristics

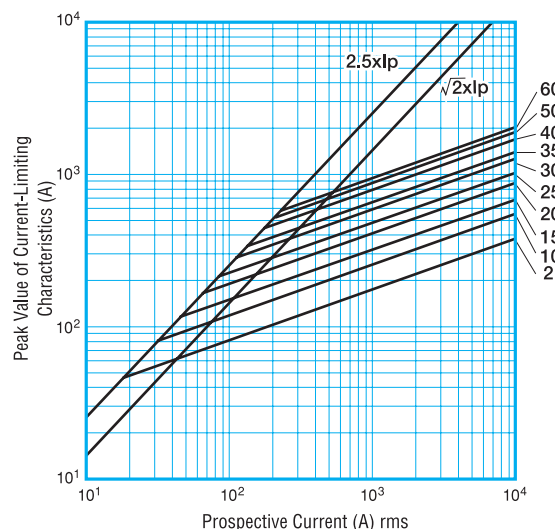

Temperature Rise 400KH

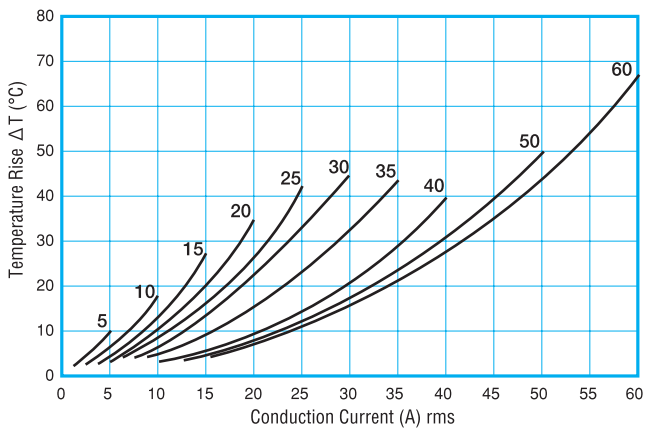

400KHK

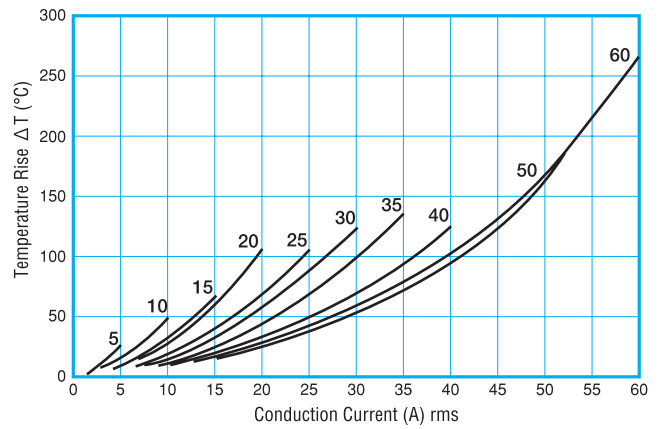

Power Loss 400KH

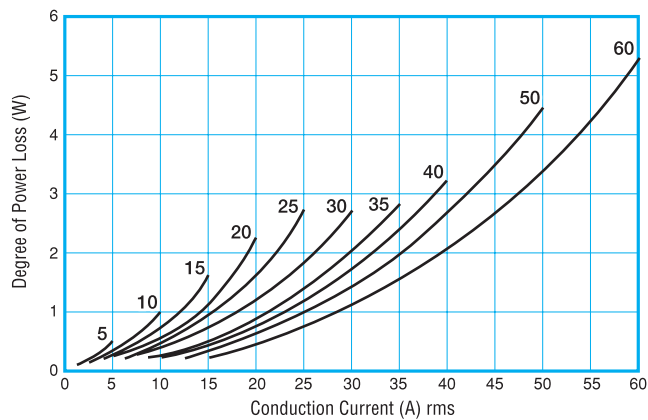

400KHK

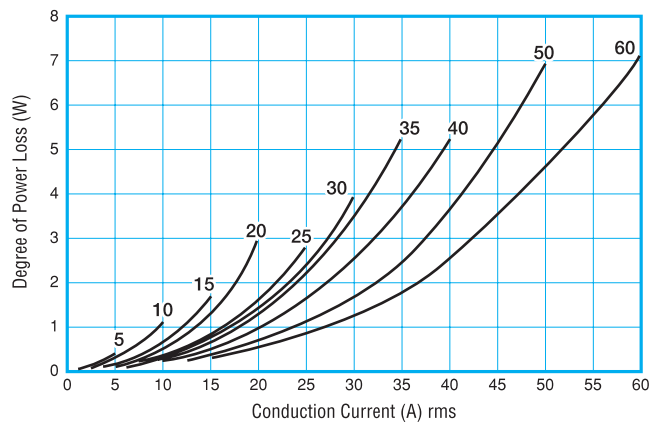

Shutdown I²t Against Working AC Voltage

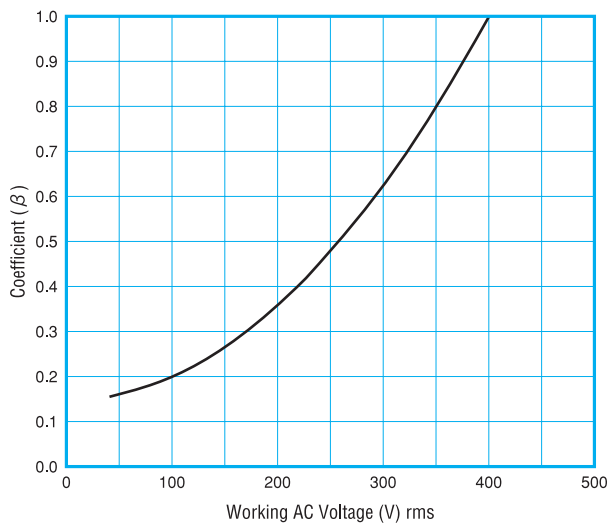

Application to Direct-Current Circuit

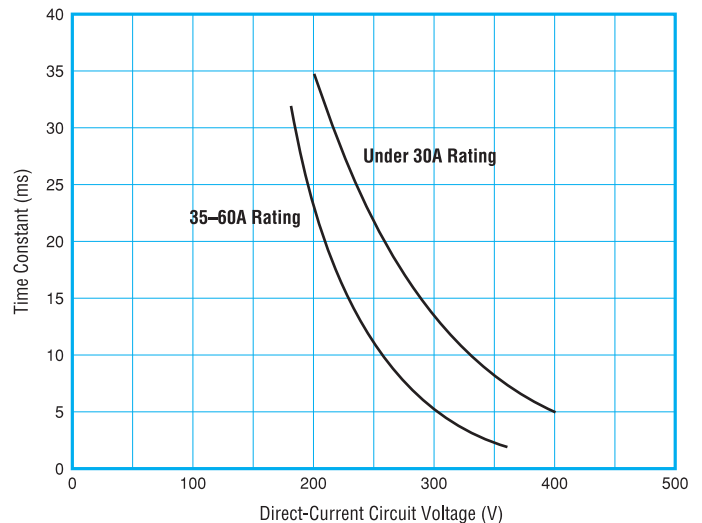

Power Loss and Temperature Characteristics

• Testing Conditions for Board-Soldered-Type Fuses

The power loss and the temperature characteristics are studied using an FR-4 board (one-side board) and a 35- μ m-thick copper foil with a copper foil width of 0.5 mm/A depending on the rated amperage (e.g., 5 mm width for a product rated at 10A).

660CF/KH/KHK

FEATURES

- Three types are available for choice according to the installation method.
- Compact and light-weight, also excellent for prompt cut-off action when blocking off.
- Most suitable for small inverters, servos, UPSs, power supplies, etc.
- Compliant with various standards.
- A 10-mm- ϕ fuse is compliant to the 50A class.

RATING

• Rating 5 to 30 A

Rated voltage and breaking capacity : 660V AC-10kA, 660V DC (L/R = 10ms)-10kA
 Minimum breaking current : 660V AC/DC – 4 times the rated amperage
 Maximum arc voltage : 1320V

• Rating 35 to 60 A

Rated voltage and breaking capacity : 660V AC-10kA, 660V DC (L/R = 10ms)-10kA
 Minimum breaking current : 660V AC – 4 times the rated amperage
 660V DC – 20 times the rated amperage
 570V DC – 8 times the rated amperage

CAUTION!

- Read "FOR SAFE USE" and "PROTECT FUSE USER'S GUIDE" at the back of this catalog before use.
- A small fuse may generate a relatively large amount of heat, so a fuse with sufficient capacity is recommended for long, continuous use.
- Fusing indication function is not provided.

Specifications

Type	Rated Amperage (A)	Fusing I^2t (A ² S)	Shutdown I^2t (A ² S) at AC660V 10KA	Power Loss (W)	Weight (g)	Fig	Standard Approved	
660CF-5UL 660KH-5UL 660KHK05UL	5	2	18	0.8	8.5	CF= Fig 1	UL ^{*1} CCC ^{*2}	
660CF-10UL 660KH-10UL 660KHK10UL				1.3				CF= Fig 1
660CF-15UL 660KH-15UL 660KHK15UL				3.0				
660CF-20UL 660KH-20UL 660KHK20UL	4.5	KH= Fig 2						
660CF-25UL 660KH-25UL 660KHK25UL	5.0							
660CF-30UL 660KH-30UL 660KHK30UL	5.5							
660CF-35UL 660KH-35UL 660KHK35UL	35	12	110	3.0	10.5	KHK= Fig 3	UL ^{*1}	
660CF-40UL 660KH-40UL 660KHK40UL				3.0				
660CF-50UL 660KH-50UL 660KHK50UL				4.5				
660CF-60UL 660KH-60UL 660KHK60UL	60	43	340	5.0	16.5			
660CF-30UL 660KH-30UL 660KHK30UL				6.1				
660CF-40UL 660KH-40UL 660KHK40UL				6.5				
660CF-50UL 660KH-50UL 660KHK50UL	50	67	500	5.3	177			
660CF-60UL 660KH-60UL 660KHK60UL				7.2				
660CF-50UL 660KH-50UL 660KHK50UL				7.4				
660CF-60UL 660KH-60UL 660KHK60UL	60	264	1950	9.8	314			
660CF-60UL 660KH-60UL 660KHK60UL				11.3				
660CF-60UL 660KH-60UL 660KHK60UL				16.5				

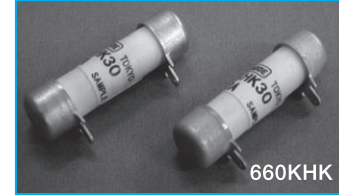

UL/cUL standard approved rating

When applying the standard to UL standard approved items, use the fuse in the following rating.

• Rating 5 to 30 A

Rated voltage and breaking capacity: Same as the standard rating.

• Rating 35 to 60 A

Rated voltage and breaking capacity : 660V AC-10kA, 570V DC (L/R = 10ms)-10kA
 *1 660KH/KHK are not cUL approved.

CCC standard approved rating

When applying the standard to CCC standard approved items, use the fuse in the following rating.

*2 The CCC standard is an option. Enter "TC" at the end of product name when ordering (e.g., 660KH-30ULTC).

Rated voltage and breaking capacity : 660V AC-10kA, 450V DC (L/R = 15ms)-10kA

Dimensions

Fig 1
660CF

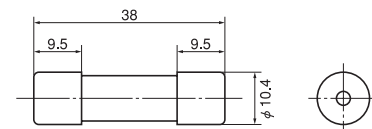

Fuse Holder HK1038
(for 660CF) refer to p. 30

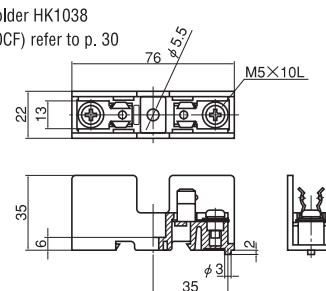

Fig 2
660KH

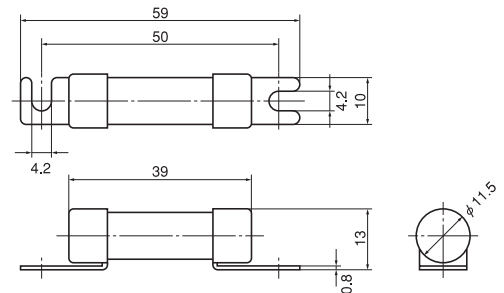
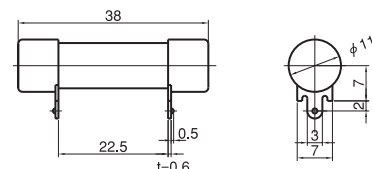
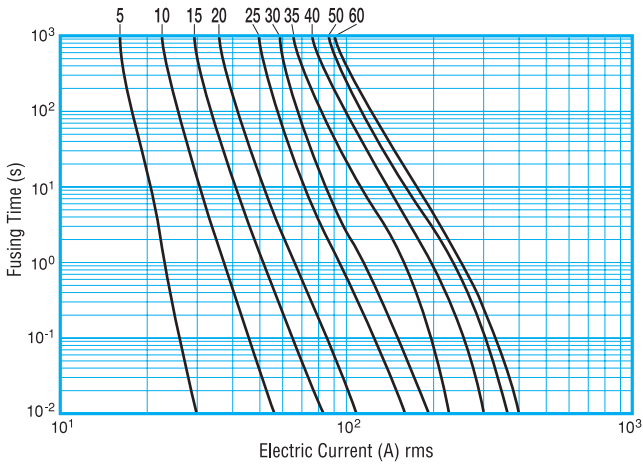

Fig 3
660KHK



Fusing Characteristics



Current-Limiting Characteristics

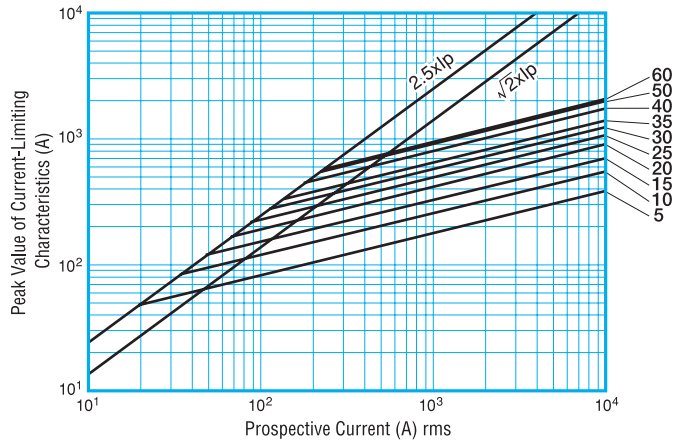

Temperature Rise

CF

KH

KHK

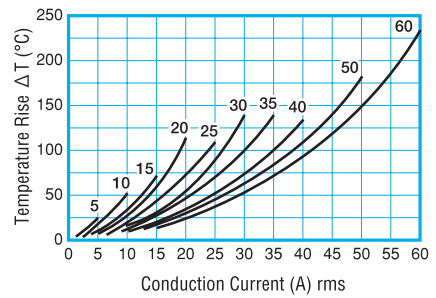
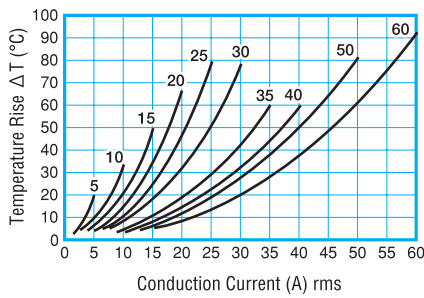
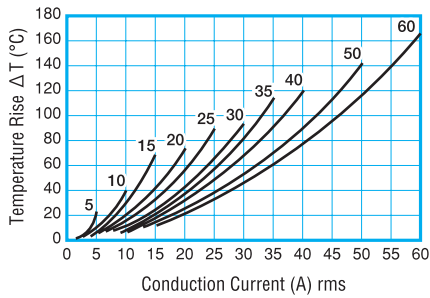

Power Loss

CF

KH

KHK

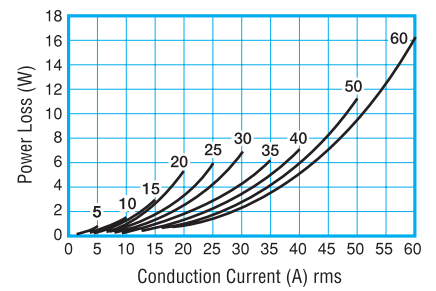
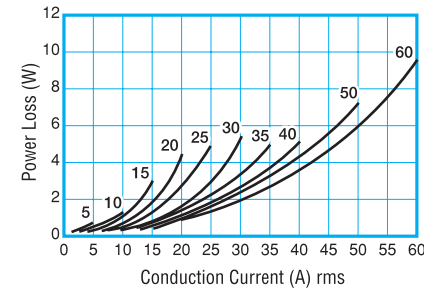
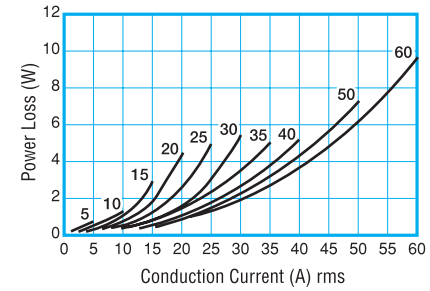

Shutdown I²t Against Working AC Voltage

Application to Direct-Current Circuit

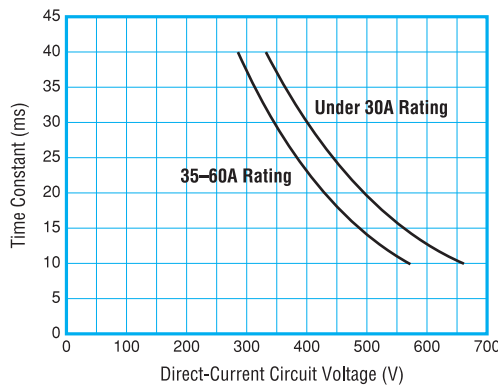
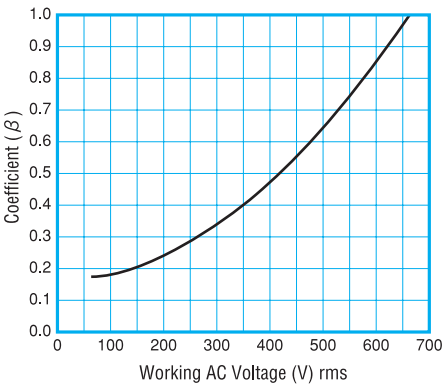

Power Loss and Temperature Characteristics

● Testing Conditions for Board-Soldered-Type Fuses

The power loss and the temperature characteristics are studied using an FR-4 board (one-side board) and a 35-μm-thick copper foil with a copper foil width of 0.5 mm/A depending on the rated amperage (e.g., 5 mm width for a product rated at 10A).

700CF/800CF/1000CF

FEATURES

- 800V DC prepared for the regeneration voltage of 400V servos/inverters.
*800CF
- Designed for small-capacity power-supply lines of a high-pressure inverter.

RATING

● 700CF–Rating 35 to 40 A

Rated voltage and breaking capacity : 700V AC–100kA, 700V DC (L/R = 10ms)–100kA
Minimum breaking current : 700V AC/DC – 4 times the rated amperage
Maximum arc voltage : 1400V

● 800CF–Rating 5 to 30 A

Rated voltage and breaking capacity : 700V AC–100kA, 800V DC (L/R = 10ms)–10kA
Minimum breaking current : 700V AC/800V DC – 4 times the rated amperage
Maximum arc voltage: 1600V

● 1000CF

Rated voltage and breaking capacity: 1000V AC–100kA
Minimum breaking current: 1000V AC – 4 times the rated amperage
Maximum arc voltage: 2000V



700CF/800CF

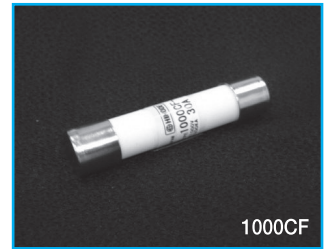

1000CF

UL standard approved rating

When applying the standard to UL standard approved items, use the fuse in the following rating.

●800CF

Rated voltage and breaking capacity: 660V AC –10kA
800V DC (L/R = 10ms)–10kA

CAUTION!

- Read “FOR SAFE USE” and “PROTECT FUSE USER’S GUIDE” at the back of this catalog before use.
- A small fuse may generate a relatively large amount of heat, so a fuse with sufficient capacity is recommended for long, continuous use.
- Fusing indication function is not provided.

Specifications 700CF/800CF

Ta=25°C

Type	Rated Amperage (A)	Fusing I ² t (A ² S)	Shutdown I ² t(A ² S) at AC660V 10KA	Shutdown I ² t(A ² S) at AC700V 100KA	Power Loss (W)	Weight (g)	Standard Approved
800CF-5UL	5	2	28	36	1.1	24	
800CF-10UL	10	6	80	110	2.6		
800CF-15UL	15	12	160	225	3.0		
800CF-20UL	20	25	310	360	6.0		
800CF-25UL	25	43	390	650	6.5		
800CF-30UL	30	67	530	1000	7.0		
700CF-35	35	93	—	1300	7.5		
700CF-40	40	121	—	1690	7.5		

Specifications 1000CF

Ta=25°C

Type	Rated Amperage (A)	Fusing I ² t (A ² S)	Shutdown I ² t(A ² S) at AC1000V 100KA	Power Loss (W)	Weight (g)	Standard Approved
1000CF-5	5	1.2	21	2.1	28	—
1000CF-10	10	4.9	83	3.2		
1000CF-15	15	19.6	332	6.6		
1000CF-20	20	44.2	750	7.2		
1000CF-30	30	123.0	2000	7.6		
1000CF-35	35	177.1	3000	8.3		

Dimensions 700CF/800CF

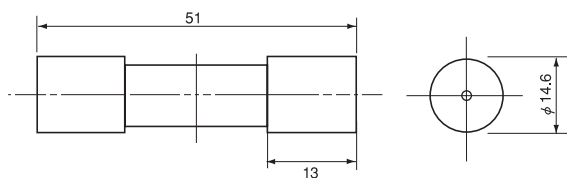

1000CF

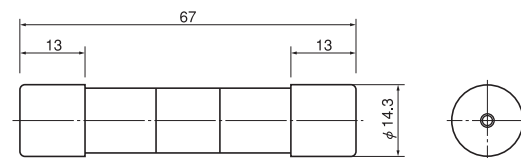

700CF/800CF

Fusing Characteristics

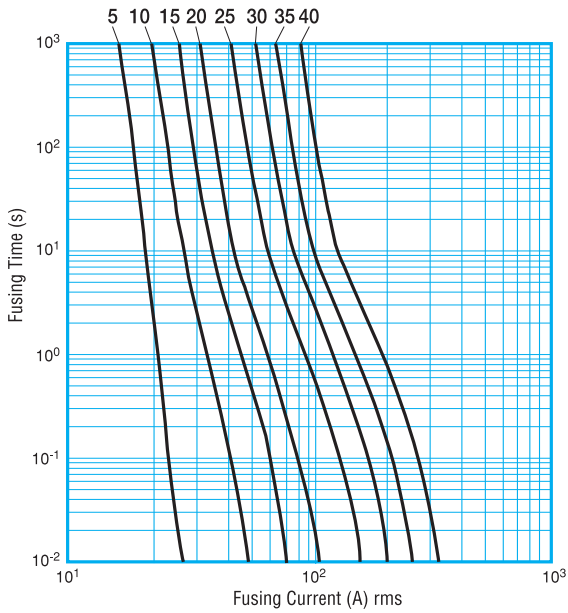

Current-Limiting Characteristics

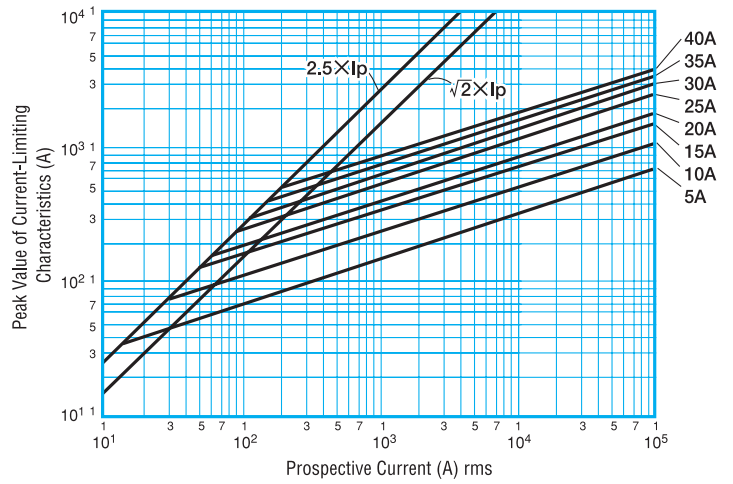

Temperature Rise

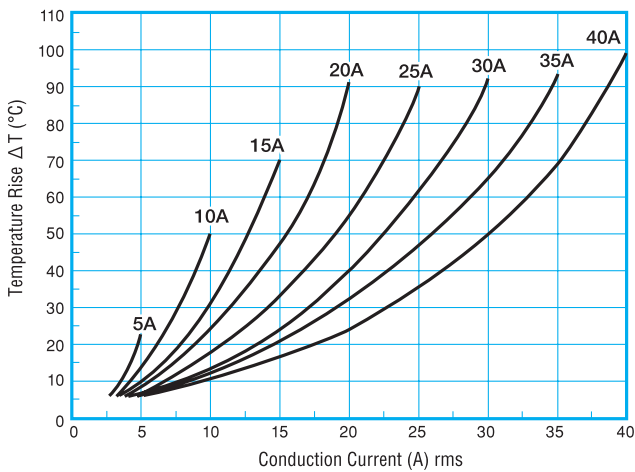

Power Loss

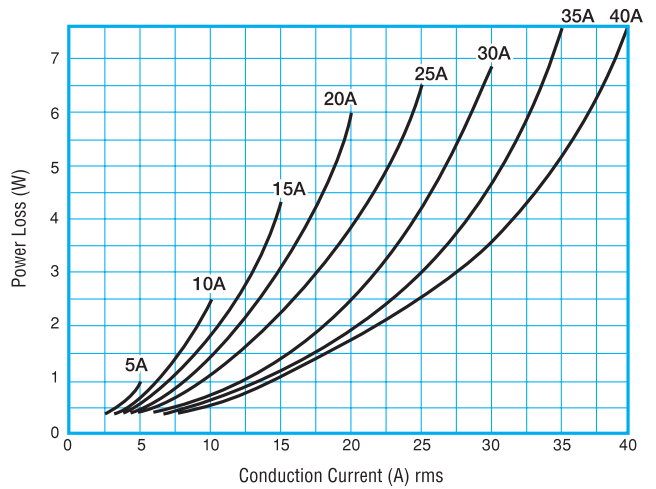

Shutdown I²t Against Working AC Voltage

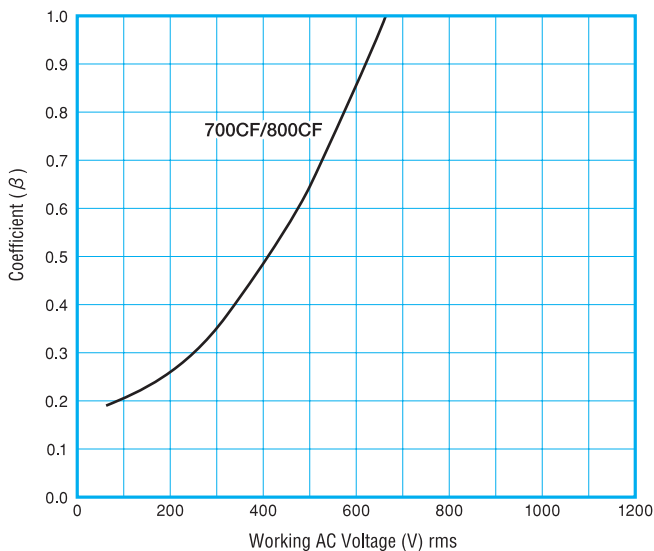

Application to Direct-Current Circuit

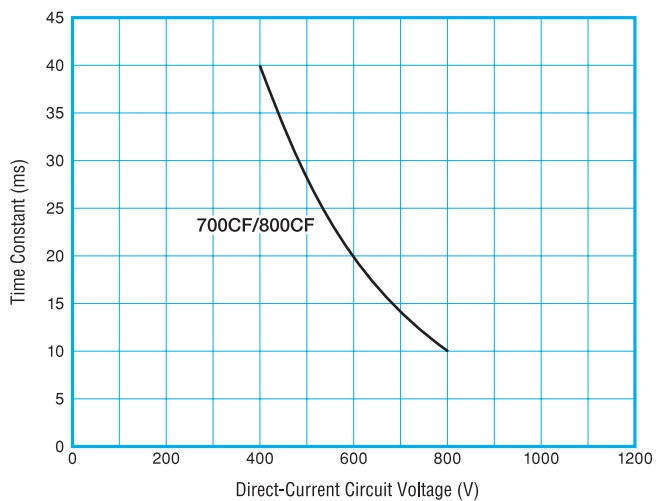

1000CF

Fusing Characteristics

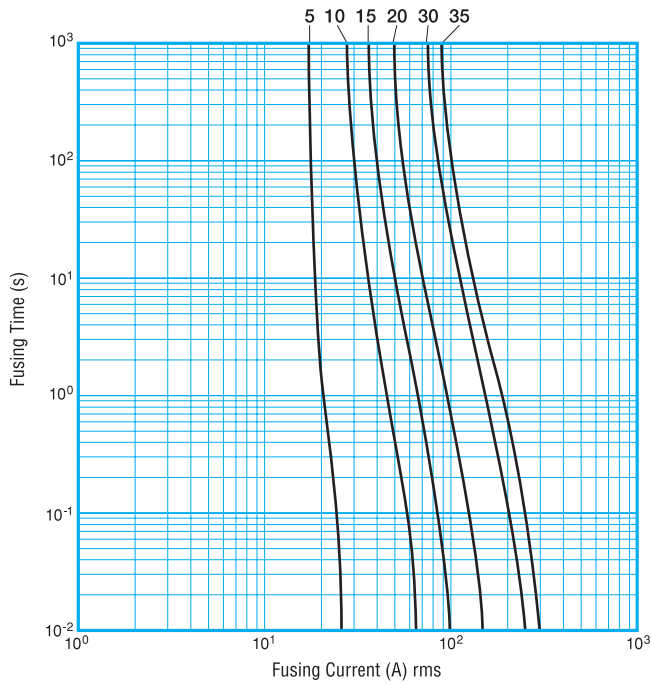

Current-Limiting Characteristics

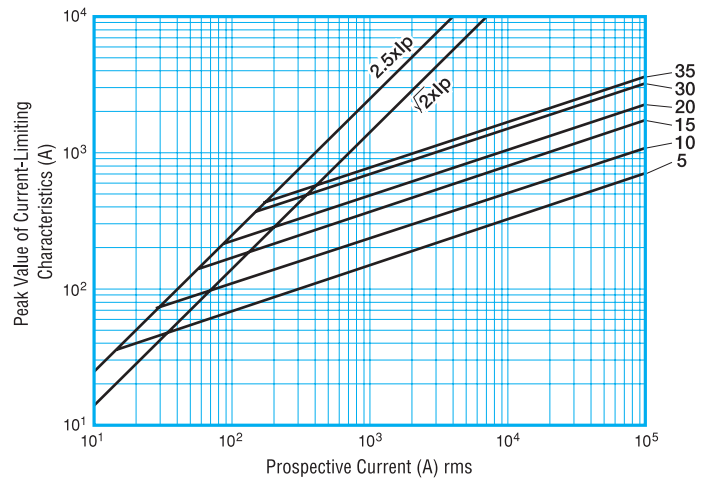

Temperature Rise

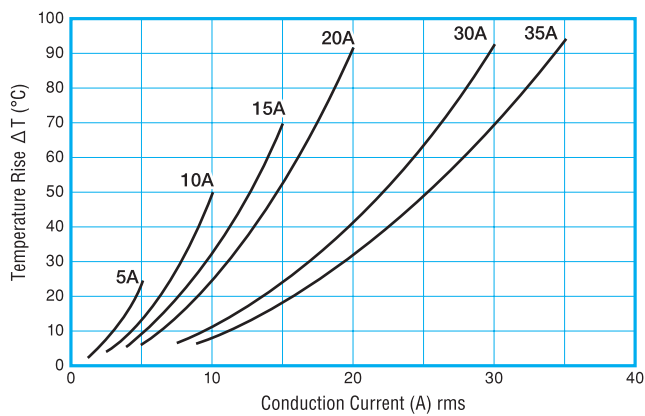

Power Loss

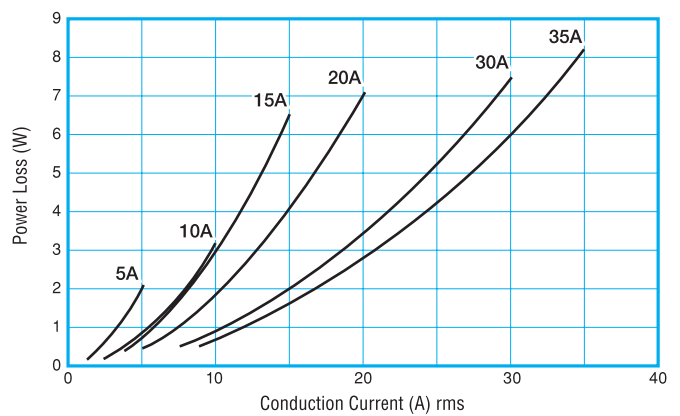

Shutdown I²t Against Working AC Voltage

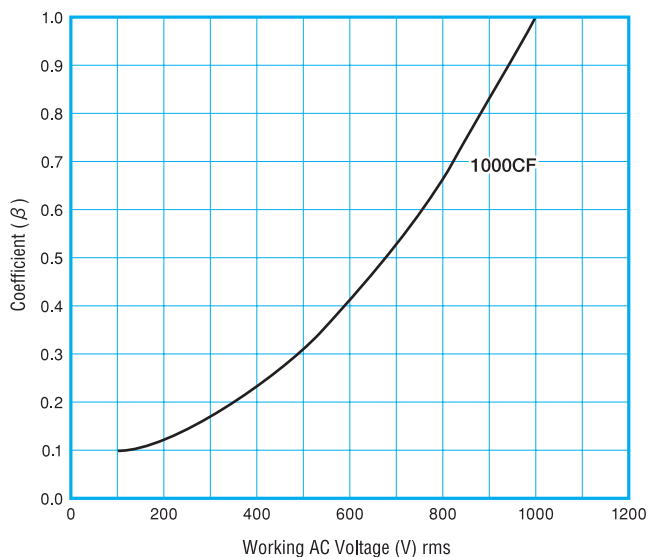

Application to Direct-Current Circuit

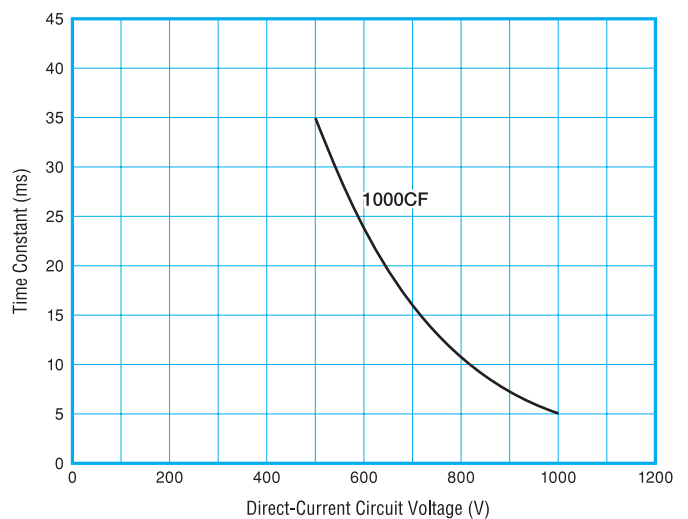

FEATURES

- A fuse with an indicator that shows evidence of fusing is also available (microswitch can be installed).
- Durable against repetitive current.
- Compliant to 400V DC (350GH)
- Compliant with various standards.

RATING

• 250GH

Rated voltage and breaking capacity : 250V AC–100kA, 250V DC (L/R = 10ms)–100kA
 Minimum breaking current : 250V AC/DC – 5 times the rated amperage
 Maximum arc voltage : 550V

• 350GH

Rated voltage and breaking capacity : 250/350V AC–100kA, 400V DC (L/R = 2ms)–10kA
 Minimum breaking current : 350V AC/400V DC – 5 times the rated amperage
 Maximum arc voltage : 700V

CAUTION!

- Read “PROTECT FUSE USER’S GUIDE” and “FOR SAFE USE” at the back of this catalog before use.
- When purchasing a product with an indicator fuse, enter “S” immediately after the ampere rating in the product name (e.g., 350GH-200SUL).
- The minimum working voltage of the indicator fuse is 10V.

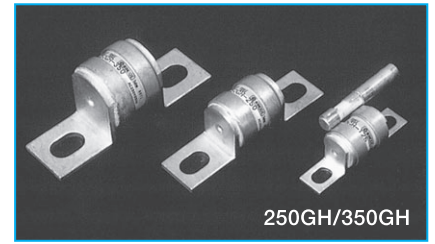

UL/cUL standard approved rating

When applying the standard to UL standard approved items, use the fuse in the following rating.

• 250GH (cUL not approved)

Rated voltage and breaking capacity : 250V AC–100kA, 250V DC (L/R = 10ms)–100kA

• 350GH

Rated voltage and breaking capacity : 380V AC–10kA, 400V DC (L/R = 2ms)–10kA

CCC standard approved rating

• 350GH

When applying the standard to CCC standard approved items, use the fuse in the following rating.

*The CCC standard is an option. Enter “TC” at the end of product name when ordering (e.g., 350GH-100ULTC).

Rated voltage and breaking capacity : 350V AC–50kA, 250V DC (L/R = 15ms)–50kA

Specifications

Type	Rated Amperage (A)	Fusing I ² t (A ² S)	Shutdown I ² t (A ² S) at AC250V-100KA	Shutdown I ² t (A ² S) at AC350V-100KA	Power Loss (W)	Dimensions (mm)										Weight (g)	Fig	Standard Approved														
						A	B	C	D	E	F	G	H	W	T				M													
350GH-16UL	16	20	230	430	1.5	55	41±3	25	27max	17.5	9.5	6.5	19	12	2	—	27	1	UL, cUL, CCC, VDE, BS, IEC													
350GH-20UL	20	35	370	680	1.7																											
350GH-25UL	25	55	530	980	2.1																											
350GH-32UL	32	80	720	1310	3.0																											
350GH-40UL	40	142	1150	2090	3.6																											
350GH-50UL	50	222	1650	3000	4.7																											
350GH-63UL	63	370	2220	4010	6.9																											
350GH-80UL	80	568	3540	6390	8.2																											
350GH-100UL	100	888	5090	9150	10.0																											
250GH-125UL	125	820	6700	—	14.0																											
350GH-125UL	125	1280	6950	12280	13.0	78	57±3	29	33max	23	14	9	26	20	3	—	76	UL, cUL, CCC, VDE, BS, IEC														
350GH-160UL	160	2275	10950	19540	17.5																											
350GH-200UL	200	3555	15740	28000	24.0																											
250GH-250UL	250	3300	23000	—	34.0																											
350GH-250	250	6480	25670	45450	24.0																											
250GH-315UL	315	6000	43000	—	35.0																											
350GH-315	315	8000	30470	53860	41.0																											
250GH-350UL	350	7400	52000	—	45.0																											
250GH-400	400	11000	75000	—	45.0																											
250GH-450	450	13500	92000	—	50.0																											
250GHW500	500	24000	160000	—	50.0	86	61±3	30	46max	37	13	11	40	30	3	—	180	UL, cUL, CCC, VDE, BS, IEC														
250GHW630	630	30000	205000	—	65.0																											
250GHW710	710	43000	280000	—	70.0																											
250GHW800	800	53000	355000	—	80.0																											
250GH-20~125	—	—	—	—	—														86	61±3	30	46max	37	13	11	40	30	6	80	380	2	UL, cUL, CCC, VDE, BS, IEC
250GH-160~250	—	—	—	—	—																											
250GH-250	—	—	—	—	—																											
250GH-315	—	—	—	—	—																											
250GH-350	—	—	—	—	—																											
250GH-400	—	—	—	—	—																											
250GH-450	—	—	—	—	—																											
250GHW500	—	—	—	—	—																											
250GHW630	—	—	—	—	—																											
250GHW710	—	—	—	—	—																											
250GHW800	—	—	—	—	—																											

Ta=25°C

Dimensions

Fig 1

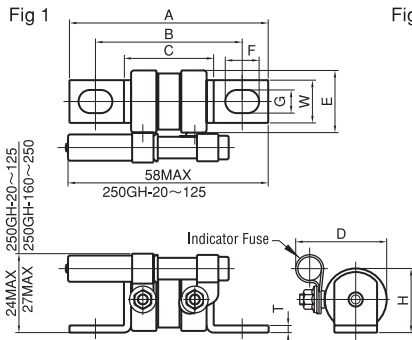
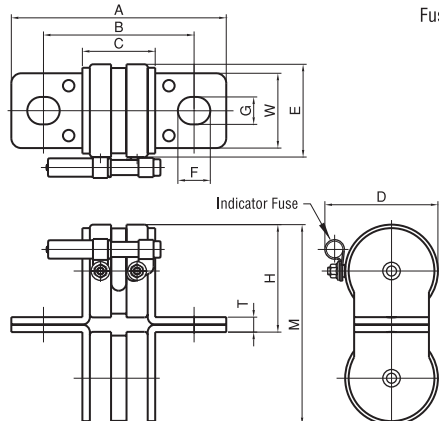
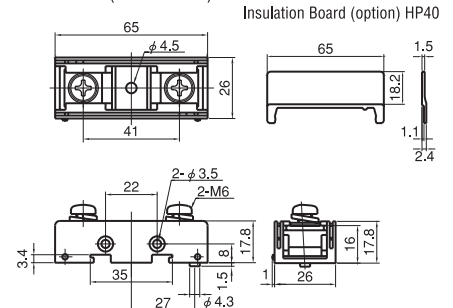

Fig 2



Fuse Holder HT4017 (refer to P.28)



250GH

Fusing Characteristics

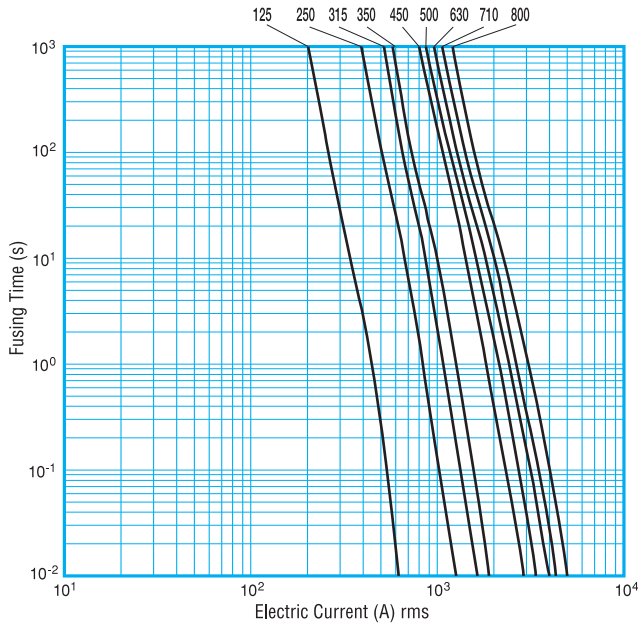

Current-Limiting Characteristics

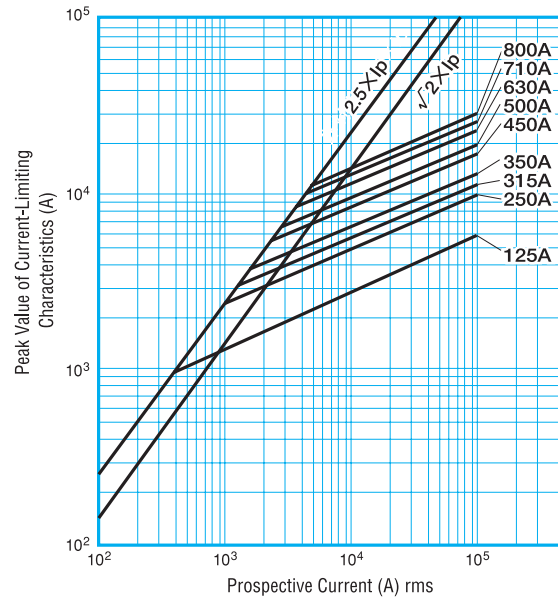

Temperature Rise

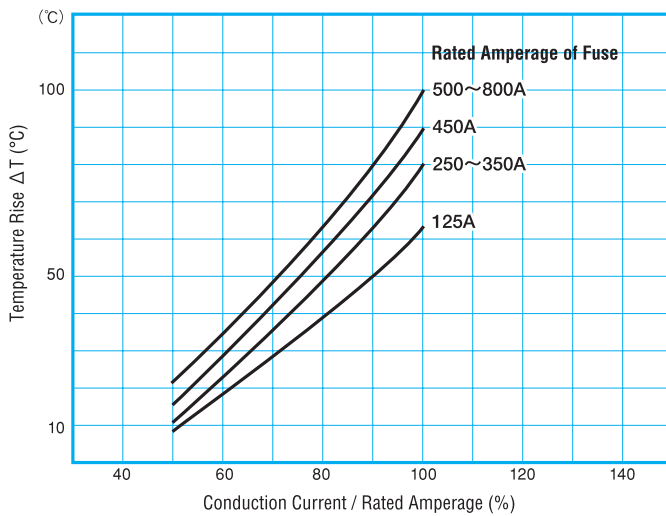

Power Loss

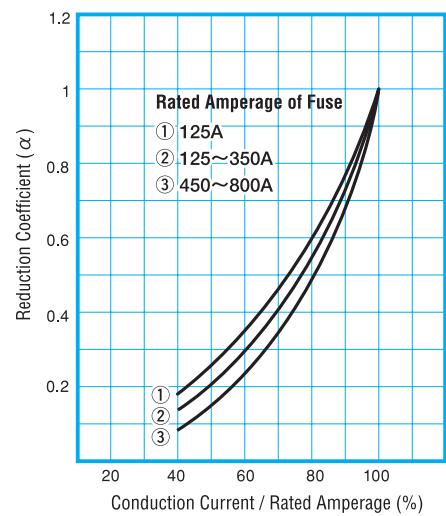

Shutdown I²t Against Working AC Voltage

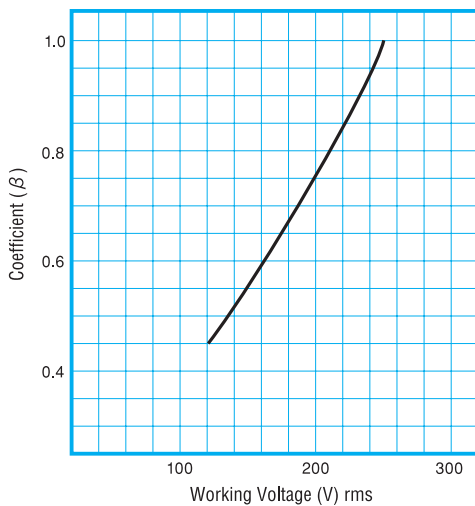

Application to Direct-Current Circuit

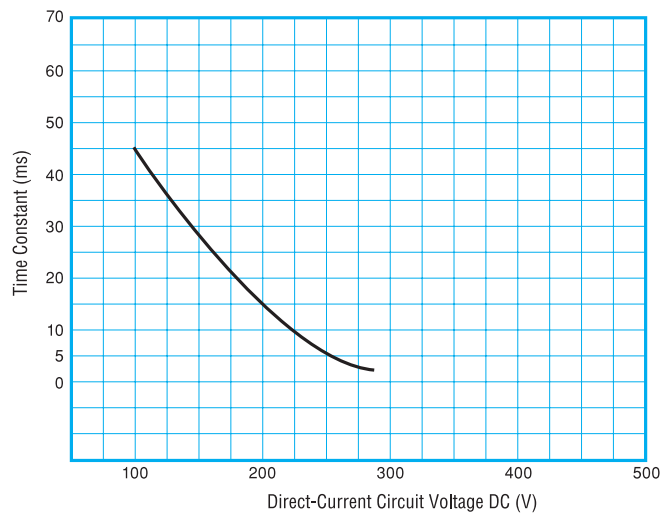

350GH

Fusing Characteristics

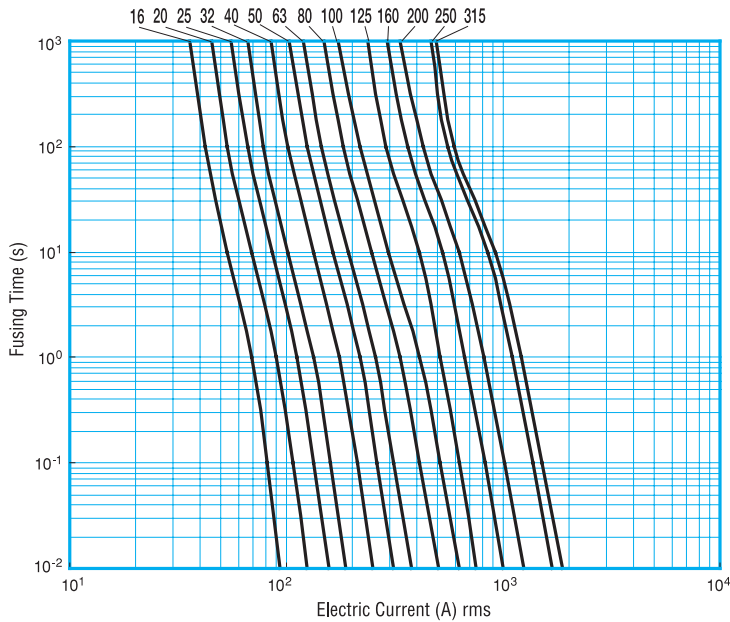

Current-Limiting Characteristics

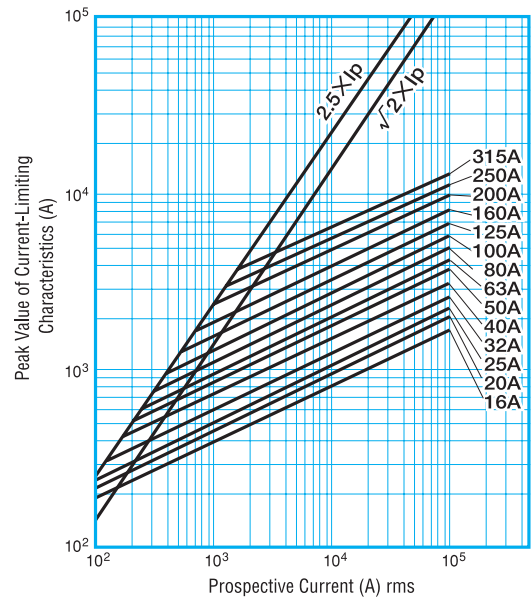

Temperature Rise

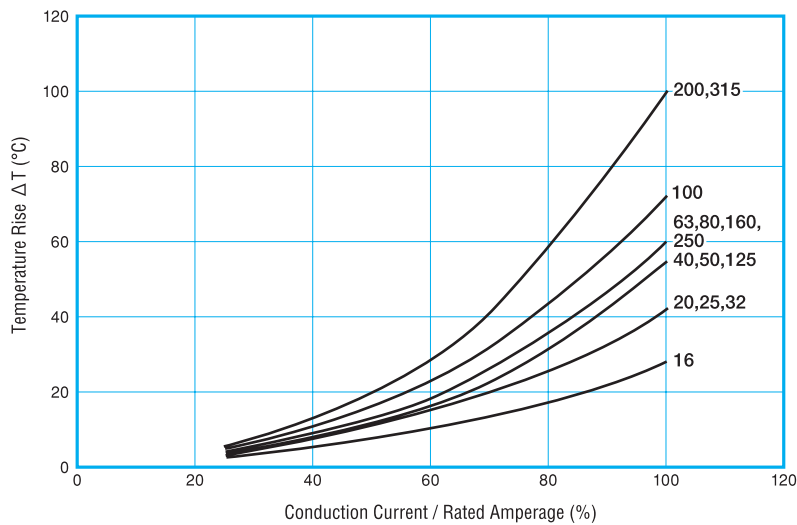

Power Loss

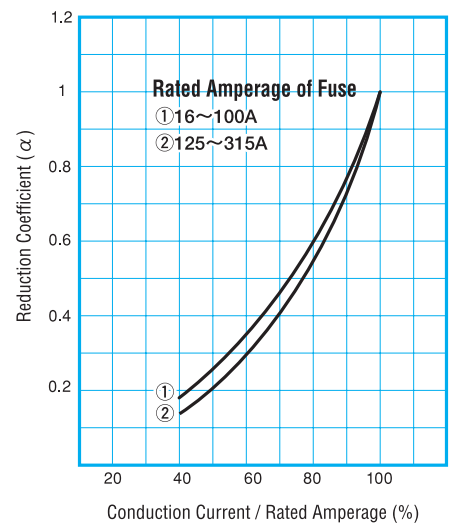

Shutdown I^2t Against Working AC Voltage

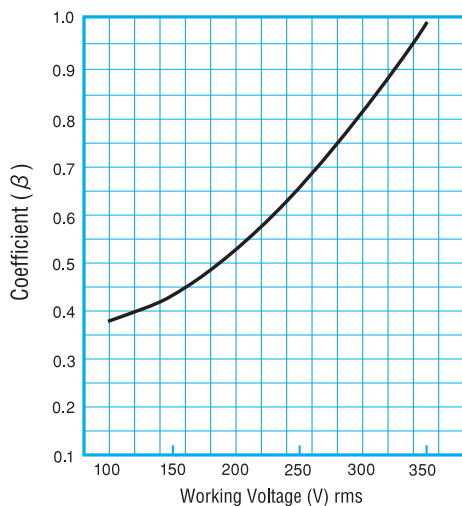

Application to Direct-Current Circuit

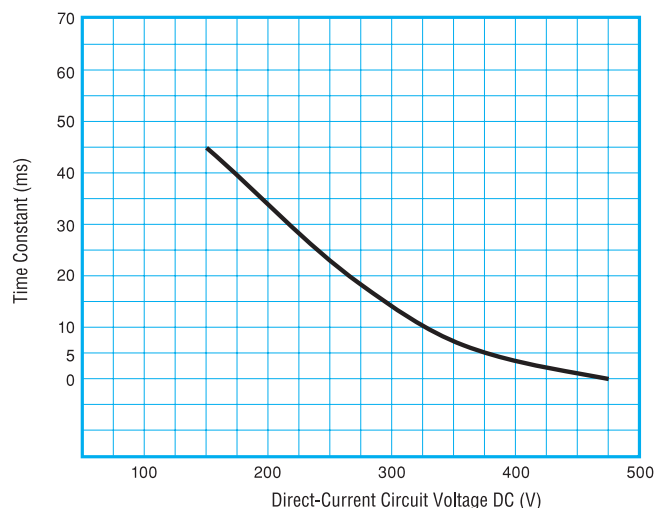

660GH

FEATURES

- A fuse with an indicator that shows evidence of fusing is also available (microswitch can be installed).
- Durable against repetitive current.
- Compliant with various standards.
- It is also effective as a fuse with high breaking performance for systems operating at 200V.

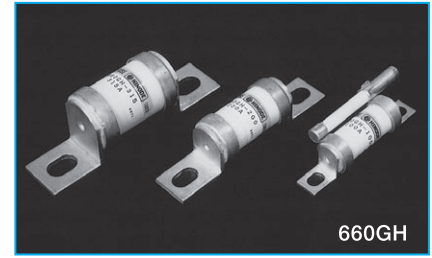

660GH

RATING

Rated voltage and breaking capacity: 660V AC–100kA,
660V DC (L/R = 10ms)–100kA
Minimum breaking current: 660V AC/DC – 5 times the rated amperage
Maximum arc voltage: 1400V

UL standard approved rating

Rated voltage and breaking capacity: Same as the standard rating

CCC standard approved rating

When applying the standard to CCC standard approved items, use the fuse in the following rating.

*The CCC standard is an option. Enter "TC" at the end of product name when ordering (e.g., 660GH-200ULTC)

Rated voltage and breaking capacity : 660V AC–50kA
450V DC (L/R = 15ms)–50kA

CAUTION!

- Read "FOR SAFE USE" and "PROTECT FUSE USER'S GUIDE" at the back of this catalog before use.
- When purchasing a product with an indicator fuse, enter "S" immediately after the ampere rating in the product name (e.g., 660GH-100SUL).
- The minimum working voltage of the indicator fuse is 10V.

Specifications

Type	Rated Amperage (A)	Fusing I ² t (A ² S)	Shutdown I ² t (A ² S) at AC660V-100KA	Power Loss (W)	Dimensions (mm)											Weight (g)	Fig	Standard Approved
					A	B	C	D	E	F	G	H	T	W	M			
660GH-16UL	16	19	220	2.0	76	61±3	46	27max	17.5	9.5	6.5	19	2	12	—	37	1	UL CCC*
660GH-20UL	20	26	310	3.5														
660GH-25UL	25	42	440	4.0														
660GH-32UL	32	74	770	6.0														
660GH-40UL	40	100	1100	7.0														
660GH-50UL	50	167	1600	9.0														
660GH-63UL	63	300	2700	12.0														
660GH-80UL	80	400	3800	17.0														
660GH-100UL	100	670	7400	22.0														
660GH-125UL	125	1200	10600	25.0														
660GH-160UL	160	2100	18000	35.0	98	77±4	50	30max	23	14	9	26	3	20	—	100	2	—
660GH-200UL	200	3300	29000	40.0														
660GH-250UL	250	6000	49500	50.0														
660GH-315UL	315	7400	63000	80.0														
660GH-350	350	11000	92000	70.0														
660GH-400	400	14000	112000	85.0														
660GH-450	450	24000	210000	85.0														
660GH-500	500	29000	270000	95.0														
660GH-630	630	42000	390000	105.0														
660GH-710	710	51000	460000	115.0														

Ta=25°C

Dimensions

Fig 1

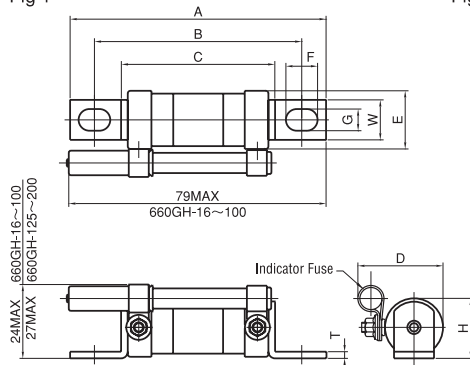
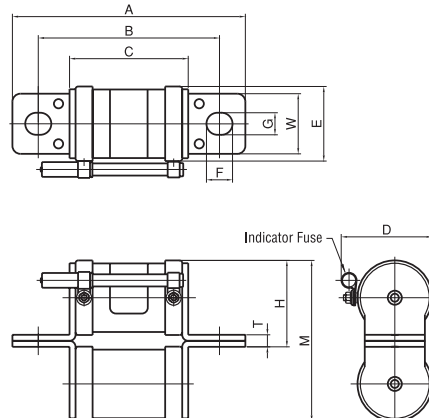
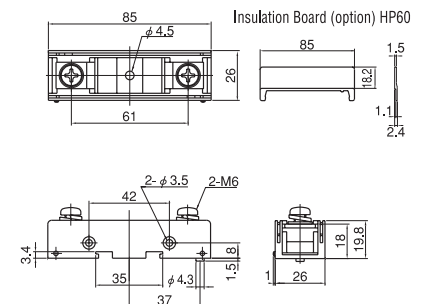

Fig 2



Fuse Holder HT6017 (refer to P.29)



Fusing Characteristics

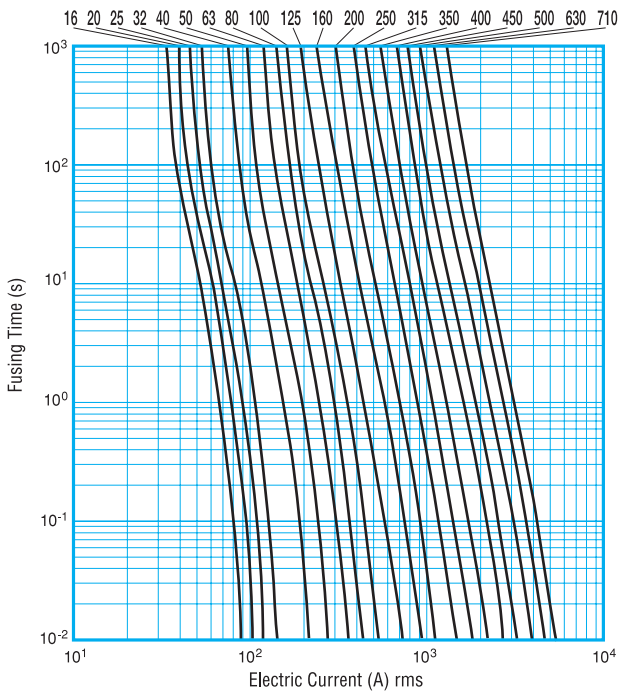

Current-Limiting Characteristics

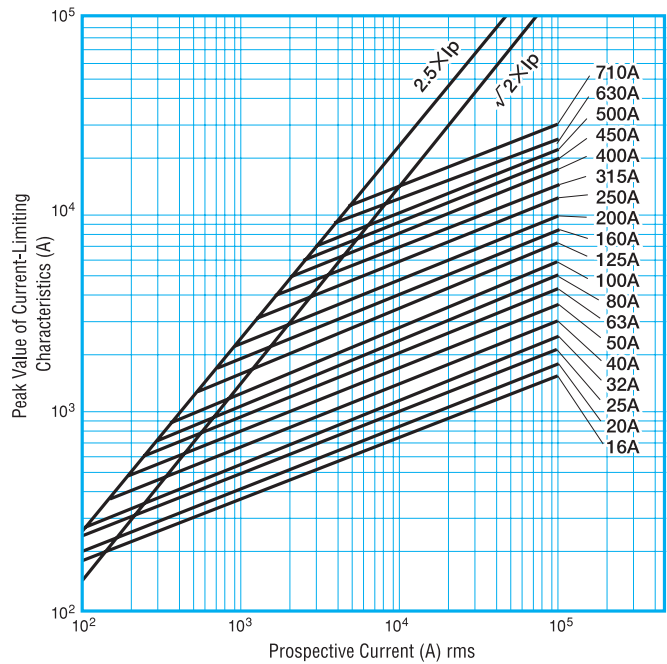

Temperature Rise

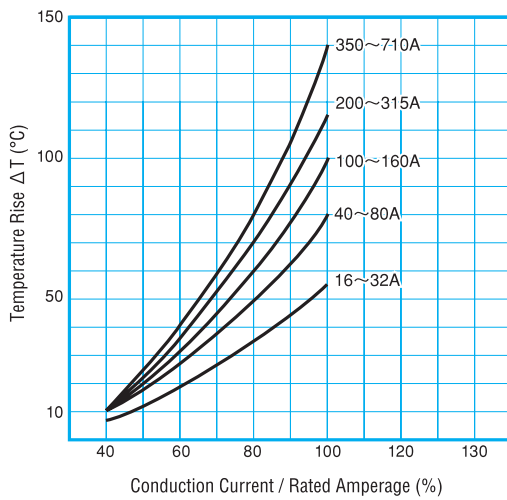

Power Loss

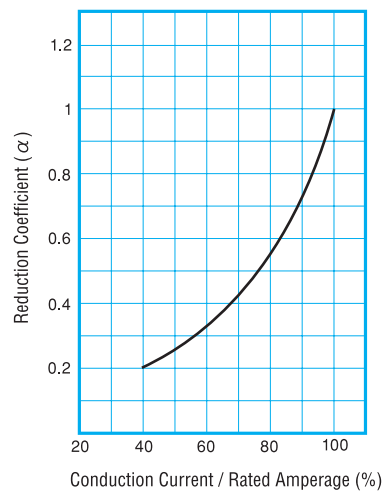

Shutdown I²t Against Working AC Voltage

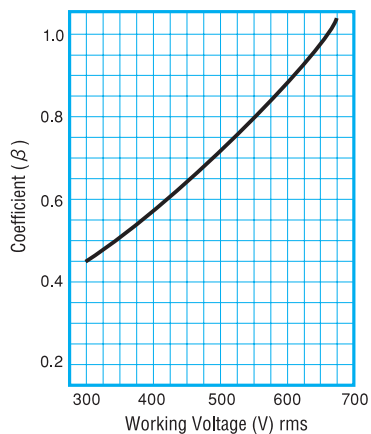

Application to Direct-Current Circuit

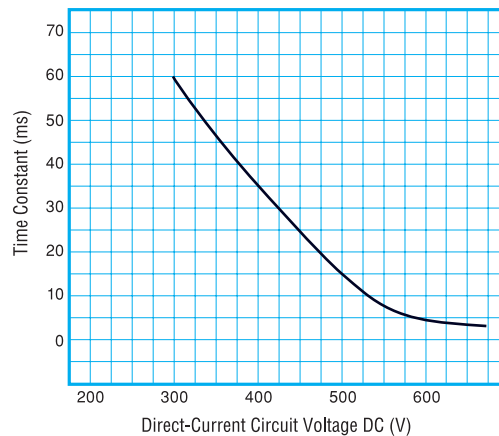

FEATURES

- A fuse with an indicator that shows evidence of fusing is also available (microswitch can be installed).
- Low-cost cylindrical fuse that is compliant to 1000V.
- It is also effective as a fuse with high breaking performance for systems operating at 400V.

RATING

Rated voltage and breaking capacity : 1000V AC–100kA
 1000V DC (L/R = 3ms)–100kA
 Minimum breaking current : 1000V AC/DC – 6 times the rated amperage
 Maximum arc voltage : 2000V

UL standard approved rating

Rated voltage and breaking capacity : Same as the standard rating

CAUTION!

- Read “PROTECT FUSE USER’S GUIDE” and “FOR SAFE USE” at the back of this catalog before use.
- When purchasing a product with an indicator fuse, enter “S” immediately after the ampere rating in the product name (e.g., 1000GH-100SUL).
- The minimum working voltage of the indicator fuse is 10V.

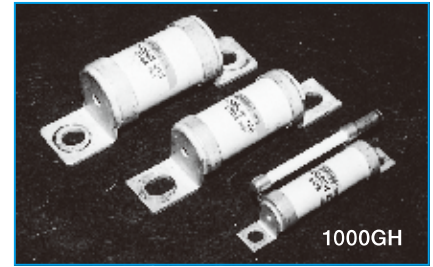

Specifications

Type	Rated Amperage (A)	Fusing I ² t (A ² S)	Shutdown I ² t(A ² S) at AC1000V-100KA	Power Loss (W)	Dimensions (mm)							Weight (g)	Fig	Standard Approved			
					A	B	C	D	E	F	G				H	W	T
1000GH-16UL	16	20	230	3.6	95	81	66	27	20	8	6.5	22	14	2	64	1	UL
1000GH-20UL	20	30	350	4.5													
1000GH-25UL	25	50	600	5.0													
1000GH-32UL	32	85	900	6.0													
1000GH-40UL	40	145	1400	8.0													
1000GH-50UL	50	230	2300	12.0													
1000GH-63UL	63	330	3200	25.0	126	99	69	39	31	16	10.5	35	25	3	196		
1000GH-80UL	80	580	5500	28.0													
1000GH-100UL	100	1000	8500	30.0													
1000GH-125UL	125	1650	15500	42.0	127	101	70	44	37	13	11	40	30	3	282		
1000GH-160UL	160	2500	22000	65.0													
1000GH-200UL	200	4000	35000	75.0													
1000GH-250UL	250	6600	62000	90.0	127	101	70	44	37	13	11	40	30	6	570	2	
1000GH-315UL	315	10000	90000	120.0													
1000GH-400UL	400	16000	145000	155.0													
1000GH-500UL	500	26400	250000	190.0													
1000GH-630UL	630	39500	370000	250.0													

Ta=25°C

Dimensions

Fig 1

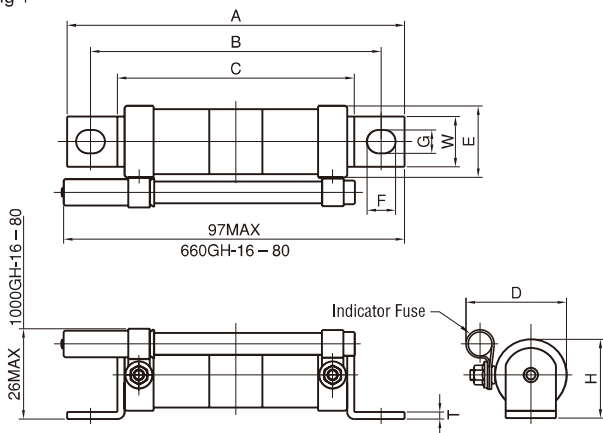
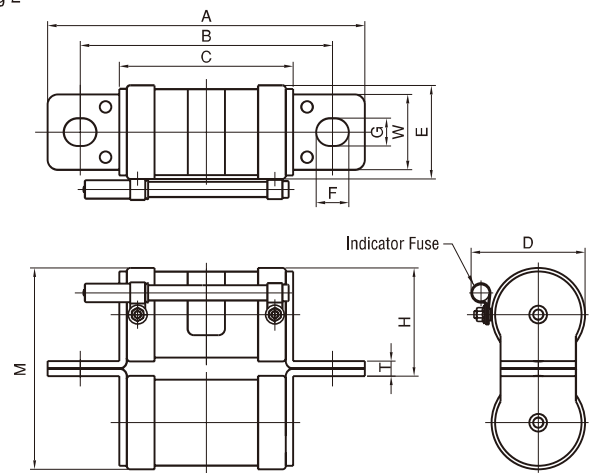
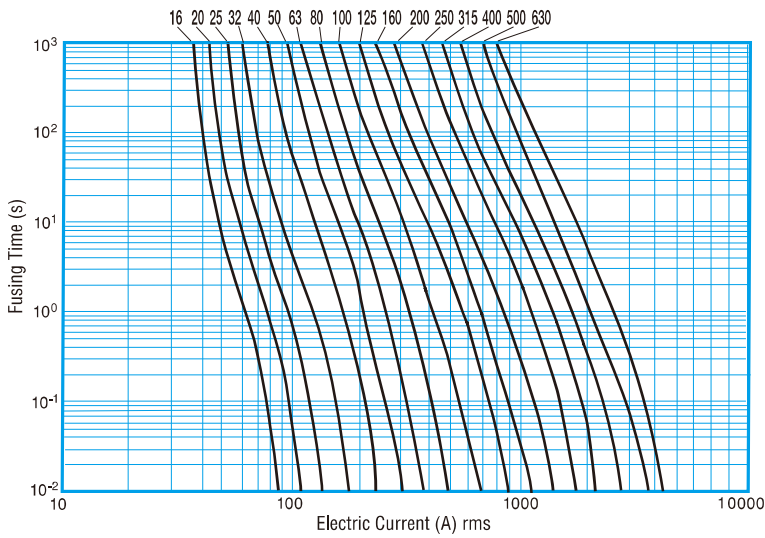

Fig 2



Fusing Characteristics



Current-Limiting Characteristics

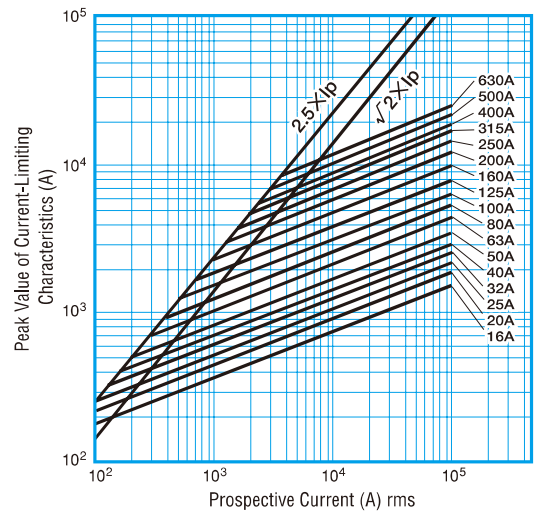

Temperature Rise

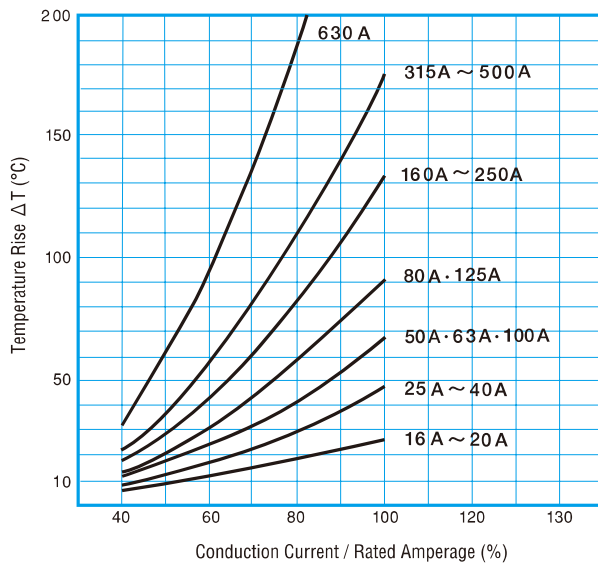

Power Loss

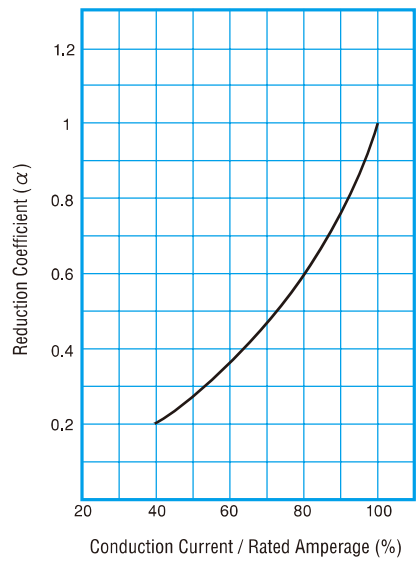

Shutdown I²t Against Working AC Voltage

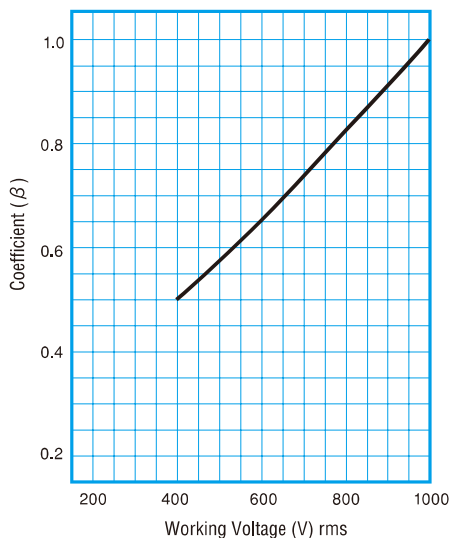

Application to Direct-Current Circuit

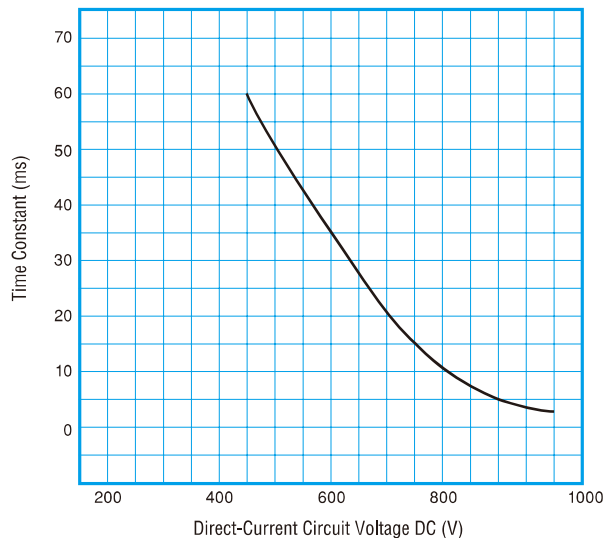

FEATURES

- Large capacity, 1750A
- Square type; capable of being connected with copper bars
- Standard model equipped with function to indicate fusing
- Microswitch can be installed (optional)

RATING

Rated voltage and breaking capacity : 600V AC–100kA
 450V DC (L/R = 3ms)–100kA
 Minimum breaking current : 600V AC/450V DC – 5 times the rated amperage
 Maximum arc voltage : 1200V

UL standard approved rating

Rated voltage and breaking capacity : Same as the standard rating

CAUTION!

- Read “PROTECT FUSE USER’S GUIDE” and “FOR SAFE USE” at the back of this catalog before use.
- The minimum working voltage of the fusing indication function is 10V.



Specifications

Dimensions

Standard Model

Ta=25°C

Type	Rated Amperage (A)	Fusing I ² t (X10 ³ A ² S)	Shutdown I ² t (X10 ³ A ² S) at AC600V 100KA	Power Loss (W)	Dimensions (mm)					Weight (g)	Fig	Standard Approved
					A	B	C	D	M			
600SPF80S	80	0.5	3.5	13	A1=30 A2=43	53	27	50	M8 Depth 8	210	1	—
600SPF100S	100	0.8	6.5	16								
600SPF125S	125	1.2	9.5	17								
600SPF160S	160	1.8	14.5	21								
600SPF200S	200	3.1	25.0	30								
600SPF250S	250	4.8	38.0	35	51	53	38	61	M10 Depth 10	420	1	—
600SPF315S	315	7.0	56.0	40								
600SPF350S	350	12.5	100.0	47								
600SPF400S	400	16.0	140.0	55								
600SPF500S	500	24.0	205.0	60								
600SPF600S	600	33.0	290.0	70	60	53	43	66	M12 Depth 12	630	1	—
600SPF630S	630	44.0	400.0	85								
600SPF700S	700	56.0	535.0	95								
600SPF800S	800	70.0	670.0	110								
600SPF900S	900	94.0	900.0	115								
600SPF1000S	1000	111.0	1060.0	135	100	58	63	87	M12 Depth 12	1830	1	—
600SPF1250PIS	1250	174.0	1580.0	180								
600SPF1500PS	1500	280.0	2700.0	200								
600SPF1750PS	1750	450.0	4500.0	250								

UL Approved Model

Type	Rated Amperage (A)	Fusing I ² t (X10 ³ A ² S)	Shutdown I ² t (X10 ³ A ² S) at AC600V 100KA	Power Loss (W)	Dimensions (mm)					Weight (g)	Fig	Standard Approved
					A	B	C	D	M			
600SPF100SUL	100	0.8	6.5	16	A1=30 A2=43	53	27	50	M8 Depth 8	210	1	UL
600SPF125SUL	125	1.2	9.5	17								
600SPF160SUL	160	1.8	14.5	21								
600SPF200SUL	200	3.1	25.0	30								
600SPF250SUL	250	4.8	38.0	35								
600SPF315SUL	315	7.0	56.0	40	51	53	38	61	M10 Depth 10	420	1	UL
600SPF350SUL	350	12.5	100.0	47								
600SPF400SUL	400	16.0	140.0	55								
600SPF500SUL	500	24.0	205.0	60								
600SPF600SUL	600	33.0	290.0	70								
600SPF630SUL	630	44.0	400.0	85	60	53	43	66	M12 Depth 12	630	1	UL
600SPF700SUL	700	56.0	535.0	95								
600SPF800SUL	800	70.0	670.0	110								
600SPF900SUL	900	94.0	900.0	115								
600SPF1000SUL	1000	111.0	1060.0	135								

Fig 1

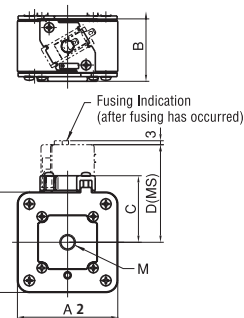

Fig 2

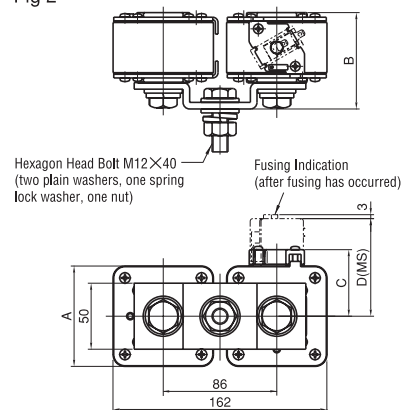
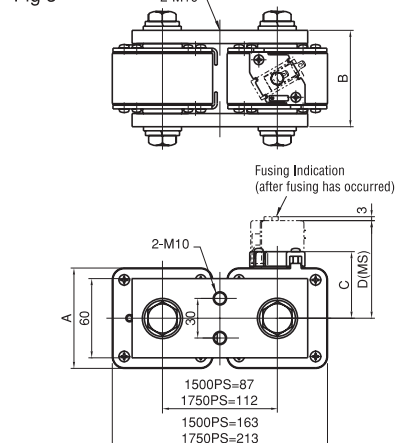
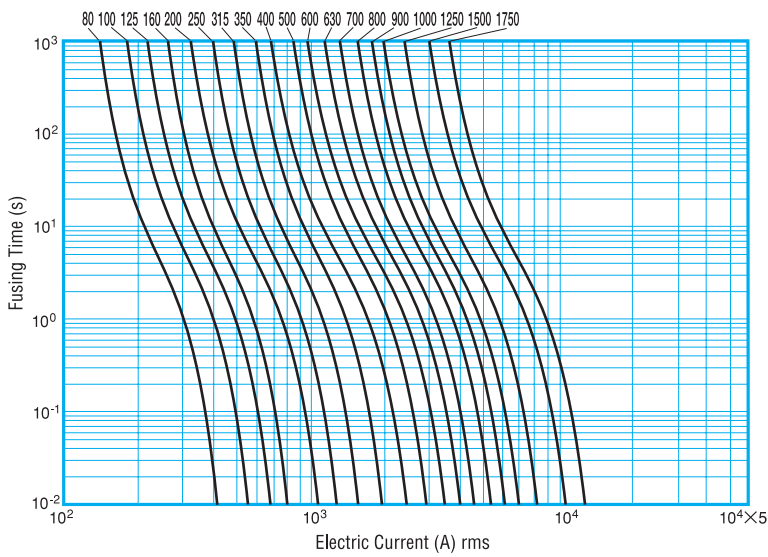

Fig 3



Fusing Characteristics



Current-Limiting Characteristics

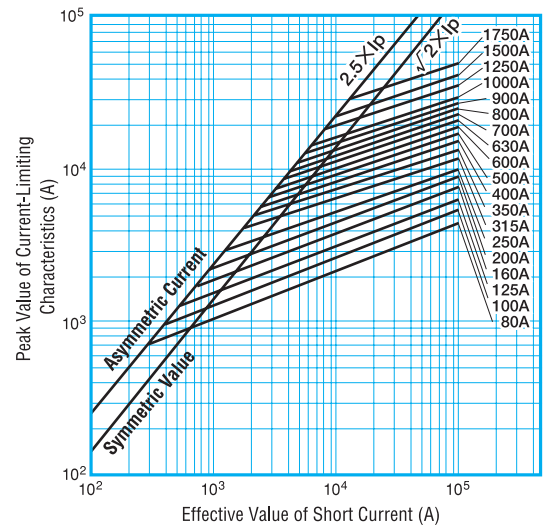

Temperature Rise

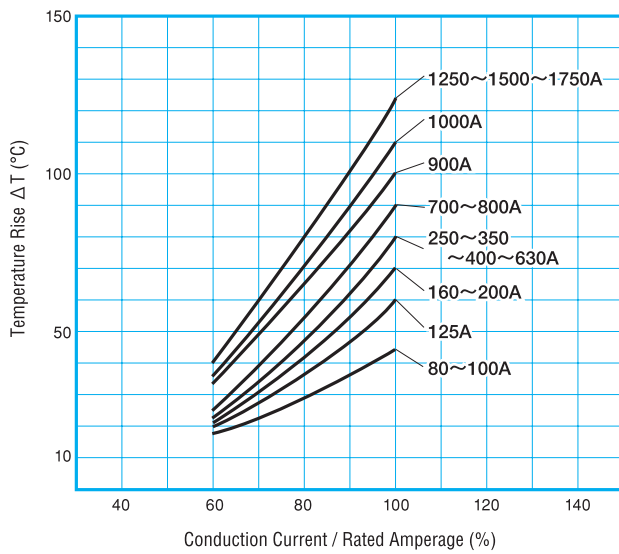

Power Loss

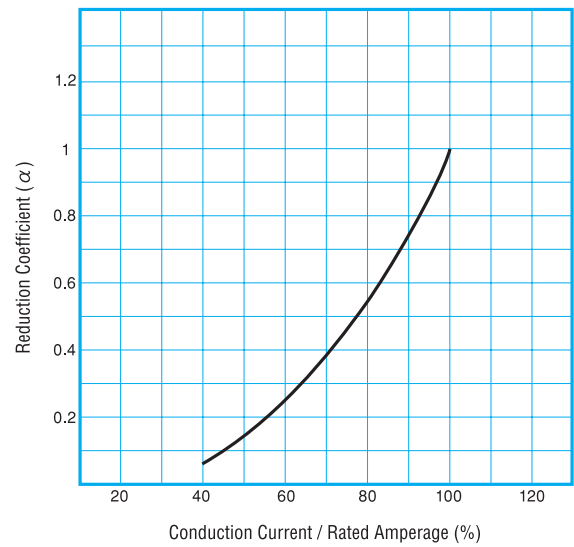

Shutdown I^2t Against Working AC Voltage

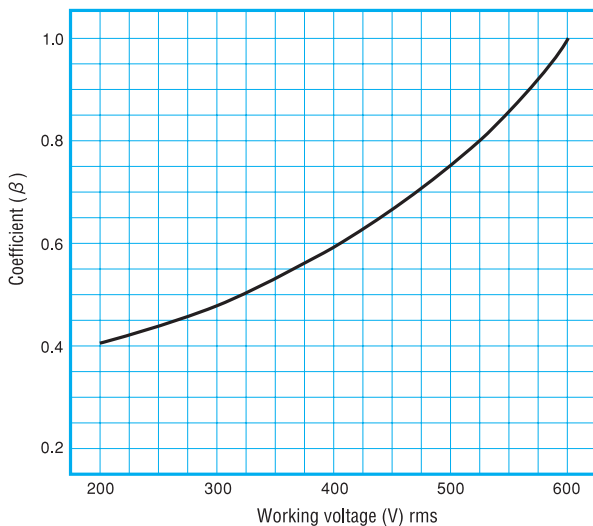

Application to Direct-Current Circuit

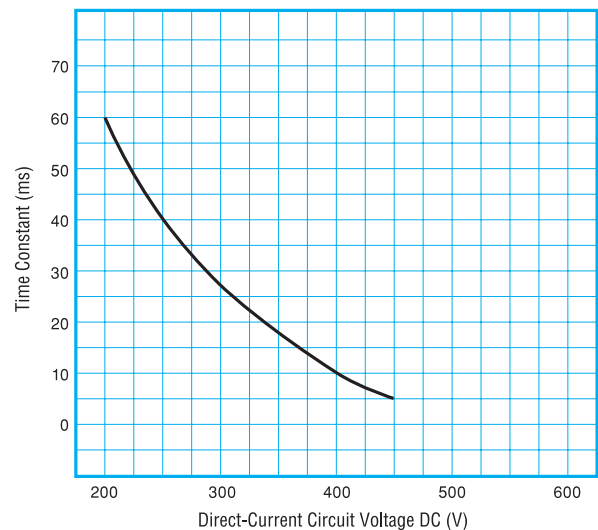

1000SPF

FEATURES

- Large-capacity, 1000V–1500A
- Square type; capable of being connected with copper bars
- Standard model equipped with function to indicate fusing
- Microswitch can be installed (optional)

RATING

Rated voltage and breaking capacity : 1000V AC–100kA
800V DC (L/R = 10ms)–100kA

Minimum breaking current : 1000V AC/800V DC – 7 times the rated amperage

Maximum arc voltage : 2000V

UL standard approved rating

Rated voltage and breaking capacity: Same as the standard rating

CAUTION!

- Read “PROTECT FUSE USER’S GUIDE” and “FOR SAFE USE” at the back of this catalog before use.
- The minimum working voltage of the fusing indication function is 10V.

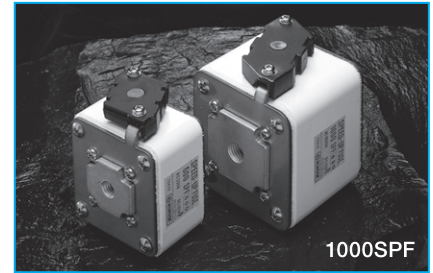

Specifications

Standard Model

Ta=25°C

Type	Rated Amperage (A)	Fusing I ² t (X10 ³ A ² S)	Shutdown I ² t (X10 ³ A ² S) at AC1000V 100KA	Power Loss (W)	Dimensions (mm)					Weight (g)	Fig	Standard Approved
					A	B	C	D	M			
1000SPF80S	80	0.9	8.0	16	A1=30 A2=43	73	27	50	M8 Depth 8	260	1	—
1000SPF100S	100	1.2	12.0	19								
1000SPF125S	125	2.0	19.0	23								
1000SPF160S	160	3.1	31.0	30								
1000SPF200S	200	4.8	47.0	35	51	73	38	61	530			
1000SPF250S	250	6.9	55.0	42								
1000SPF315S	315	12.5	123.0	56								
1000SPF350S	350	16.0	157.0	60	60	73	43	66	800			
1000SPF400S	400	23.0	210.0	66								
1000SPF500S	500	33.0	325.0	95	75	73	51	75	1290			
1000SPF630S	630	63.0	590.0	125	100	79	63	87	M12 Depth 12	2300		
1000SPF700S	700	70.0	670.0	135								
1000SPF800S	800	94.0	900.0	160								
1000SPF1000P1S	1000	133.0	1330.0	185	75	93	51	75	3200	2		
1000SPF1250P1S	1250	250.0	2360.0	240	100	99	63	87	M12 Depth 12	6300	3	
1000SPF1500PS	1500	380.0	3700.0	340								

UL Approved Model

Type	Rated Amperage (A)	Fusing I ² t (X10 ³ A ² S)	Shutdown I ² t (X10 ³ A ² S) at AC1000V 100KA	Power Loss (W)	Dimensions (mm)					Weight (g)	Fig	Standard Approved
					A	B	C	D	M			
1000SPF100SUL	100	1.2	12.0	19	51	73	38	61	M8 Depth 8	530	1	UL
1000SPF125SUL	125	2.0	19.0	23								
1000SPF160SUL	160	3.1	31.0	30								
1000SPF200SUL	200	4.8	47.0	35								
1000SPF250SUL	250	6.9	55.0	42								
1000SPF315SUL	315	12.5	123.0	56	60	73	43	66	M10 Depth 10	800		
1000SPF350SUL	350	16.0	157.0	60								
1000SPF400SUL	400	23.0	210.0	66	75	73	51	75	M12 Depth 12	1290		
1000SPF500SUL	500	33.0	325.0	95								
1000SPF630SUL	630	63.0	590.0	125								
1000SPF700SUL	700	70.0	670.0	135	100	79	63	87	M12 Depth 12	2300		
1000SPF800SUL	800	94.0	900.0	160								

Dimensions

Fig 1

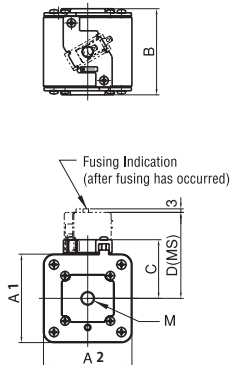

Fig 2

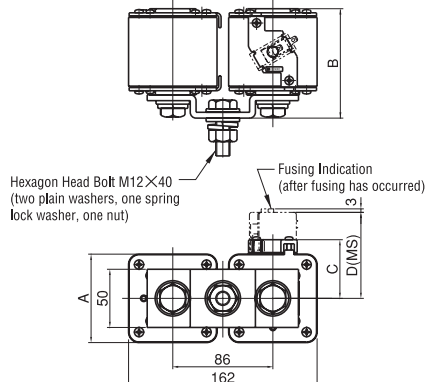
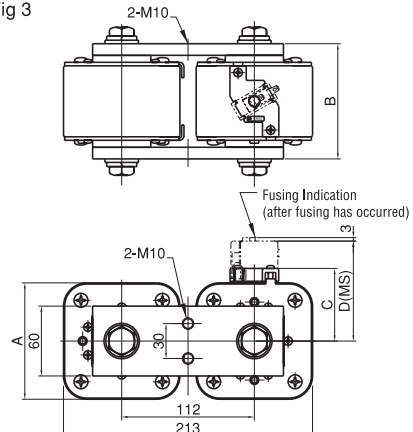
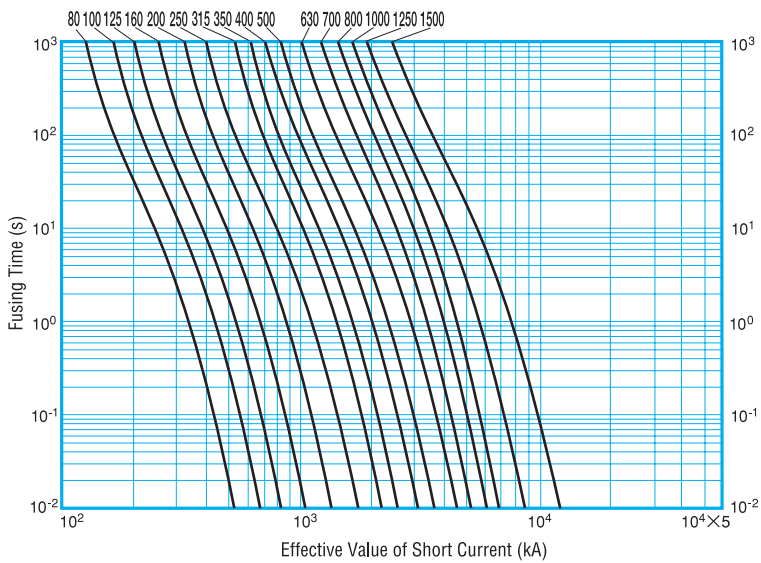

Fig 3



Fusing Characteristics



Current-Limiting Characteristics

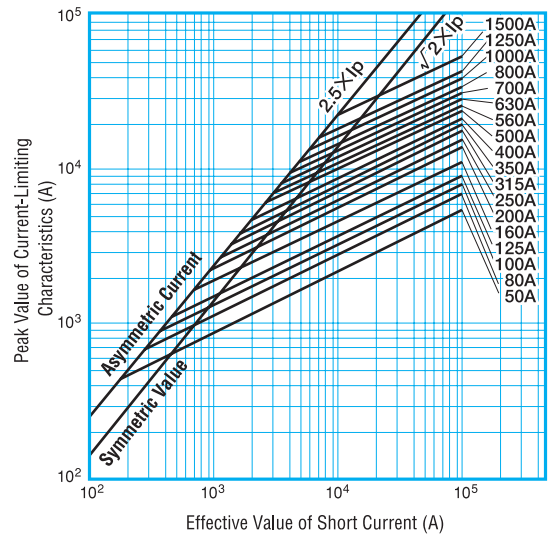

Temperature Rise

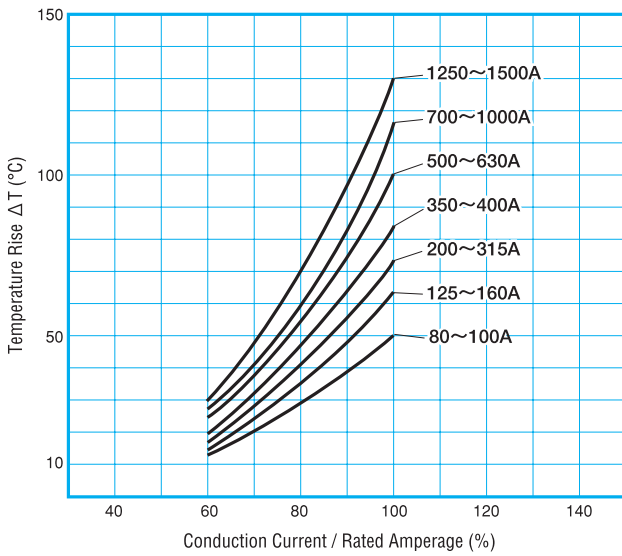

Power Loss

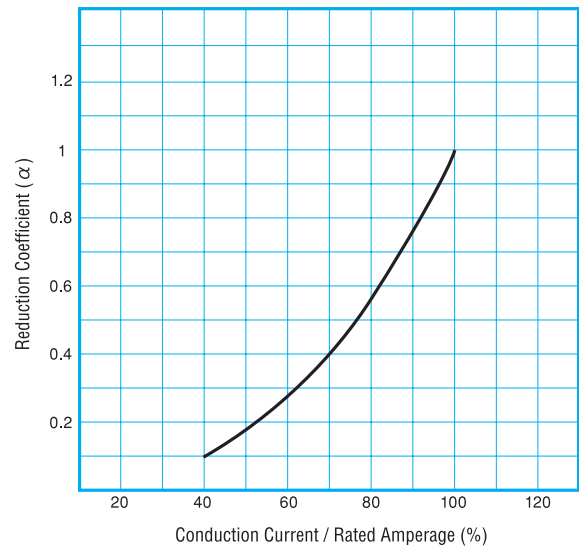

Shutdown I²t Against Working AC Voltage

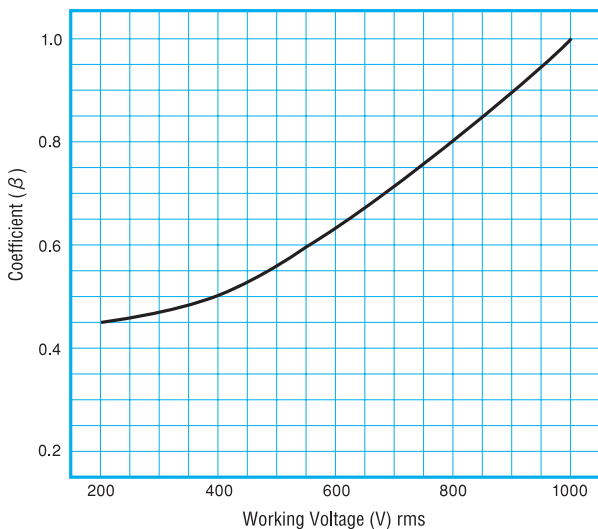

Application to Direct-Current Circuit

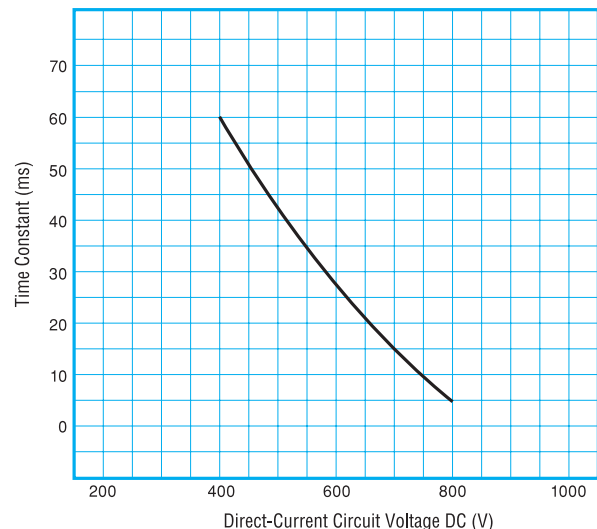

1500SPF

FEATURES

- Large-capacity, 1500V–1200A
- Square type; capable of being connected with copper bars
- Standard model equipped with function to indicate fusing
- Microswitch can be installed (optional)

RATING

Rated voltage and breaking capacity : 1500V AC–100kA
 Minimum breaking current : 1500V AC – 10 times the rated amperage
 Maximum arc voltage : 3000V

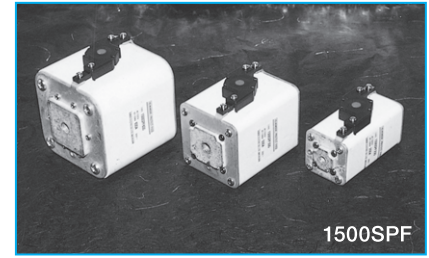

1500SPF

CAUTION!

- Read “PROTECT FUSE USER’S GUIDE” and “FOR SAFE USE” at the back of this catalog before use.
- The minimum working voltage of the fusing indication function is 10V.

Specifications

Standard Model

Ta=25°C

Type	Rated Amperage (A)	Fusing I ² t (X10 ³ A ² S)	Shutdown I ² t (X10 ³ A ² S) at AC1500V 100KA	Power Loss (W)	Dimensions (mm)					Weight (g)	Fig	Standard Approved
					A	B	C	D	M			
1500SPF50S	50	0.5	3.4	11	A1=30 A2=43	103	27	50	M8 Depth 8	370	1	—
1500SPF75S	75	1.0	6.8	20								
1500SPF100S	100	2.0	13.5	29	51	105	38	61	700			
1500SPF150S	150	4.0	27.0	40								
1500SPF200S	200	7.9	54.0	63	60	105	43	66	1100			
1500SPF250S	250	12.4	111.0	67								
1500SPF300S	300	15.7	149.0	80	75	105	51	75	1700			
1500SPF350S	350	23.4	216.0	95								
1500SPF400S	400	27.8	255.0	105	100	108	63	87	3000			
1500SPF450S	450	37.9	325.0	120								
1500SPF500S	500	49.5	396.0	140	75	125	51	75	3800			
1500SPF550S	550	74.0	598.0	148								
1500SPF600S	600	88.0	710.0	155	100	124	63	87	6600			
1500SPF800P1S	800	115.0	992.0	220								
1500SPF1000P1S	1000	195.0	1600.0	260	100	124	63	87	6600			
1500SPF1200P1S	1200	360.0	2850.0	350								

Dimensions

Fig 1

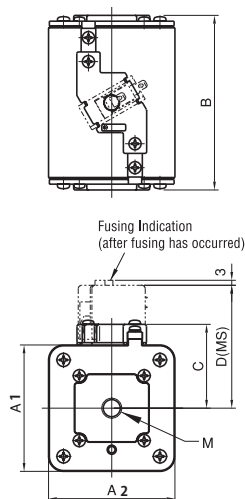
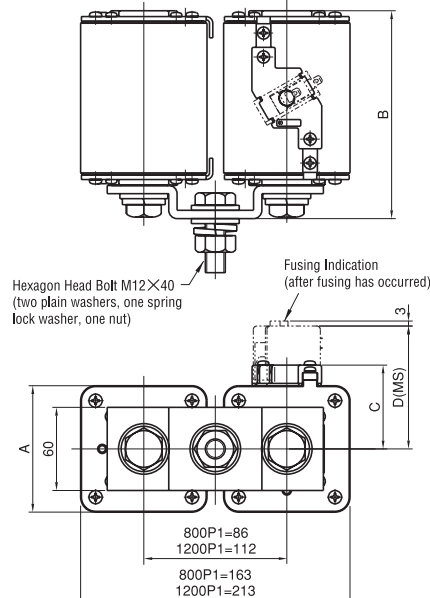
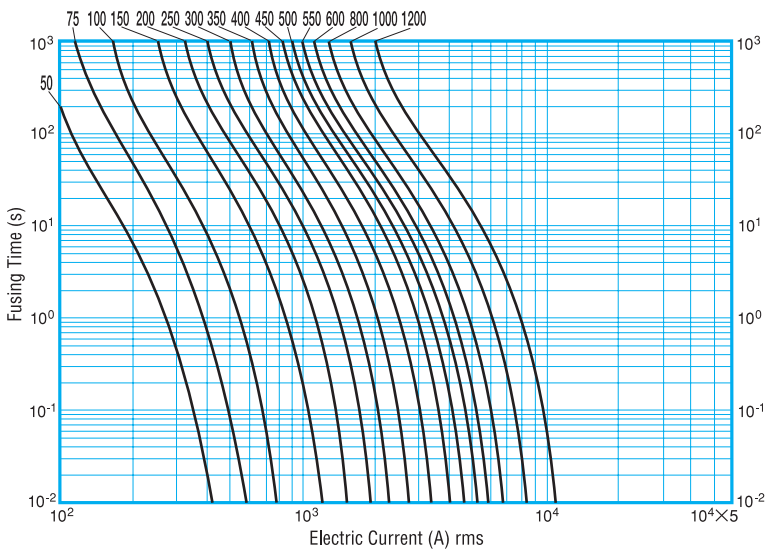

Fig 2



Fusing Characteristics



Current-Limiting Characteristics

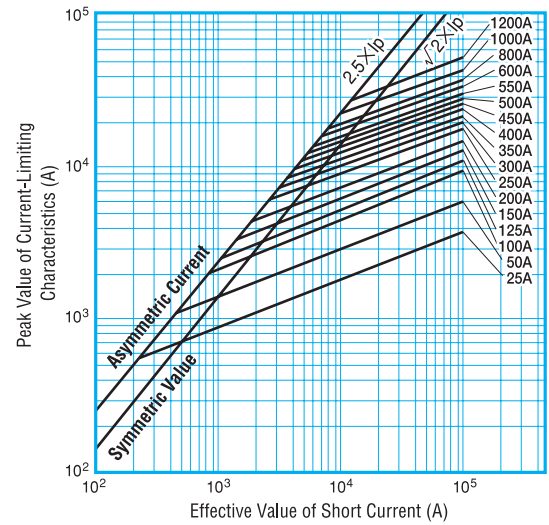

Temperature Rise

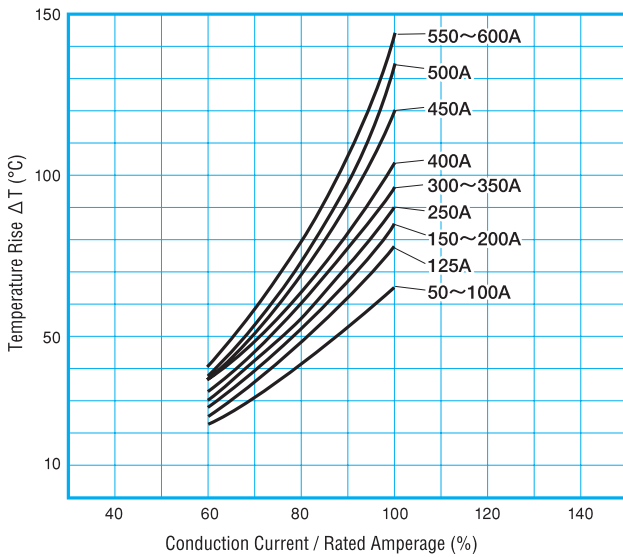

Power Loss

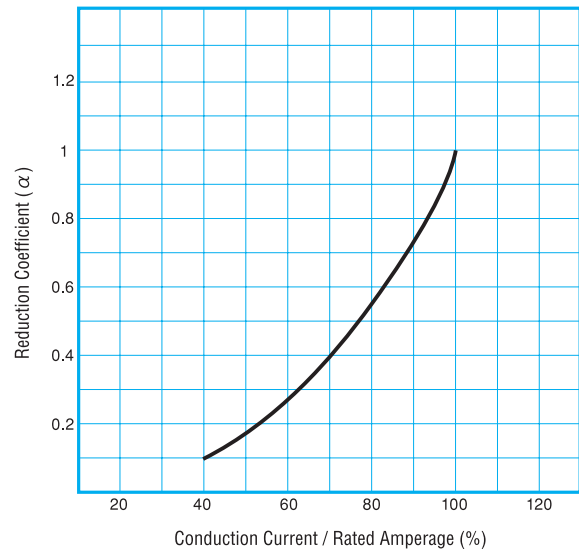

Shutdown I^2t Against Working AC Voltage

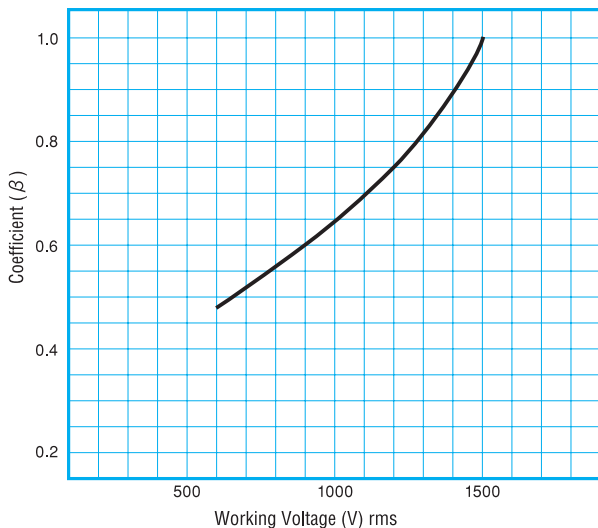

Application to Direct-Current Circuit

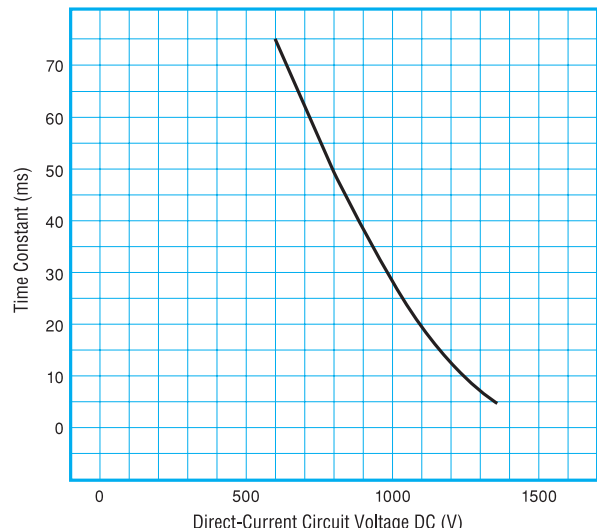

OPTIONS

FUSE HOLDERS

◆ For cylindrical fuses

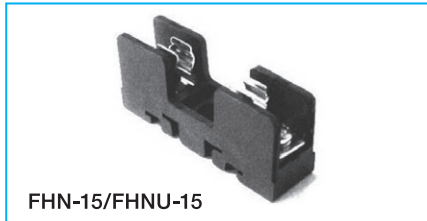

FHN-15/FHNU-15



HK1038/HK1038UL



FH-30/FHU-30

Specifications

	FHN-15/FHNU-15	HK1038/HK1038UL	FH-30/FHU-30
Rated Voltage	250V	700V	600V (UL model : 250 V)
Rated Amperage*1	15A	30A	30A
Applicable Wires	Up to 5.5mm ² (M4)	Up to 8mm ² (M5)	Up to 14mm ² (M5)
Installation	DIN rails and direct installation	DIN rails and direct installation	DIN rails and direct installation
Applicable fuses	JIS MS60 [φ 6.4×31] (Our product 250SF/500SF Series*2)	JIS MF01 [φ 10.3×38.1] (Our product 660CF Series*2)	JIS CF2 [φ 15×51] (Our product 800CF Series*2)
Material	PBT	PBT	PBT
Name of UL Approved Product	FHNU-15	HK1038UL	FHU-30
Options	Fuse holder cover FH-15d	Fuse holder cover HC-10	Fuse holder cover FH-30d
Installing Hole Size	 (only FHNU-15)		

Dimensions

FHN-15/FHNU-15

HK1038/HK1038UL

FH-30/FHU-30

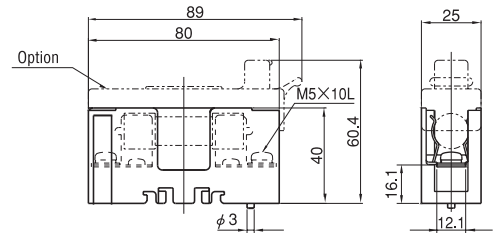
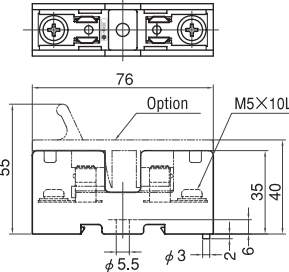
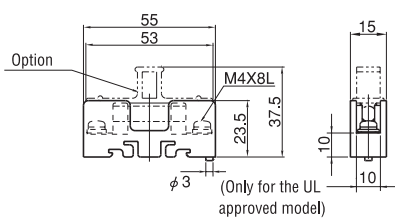

◆ For screwing type fuses

Specifications/Dimensions

HT4017

HT4017T2

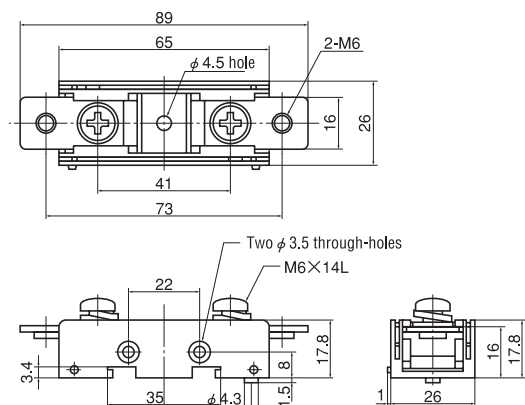
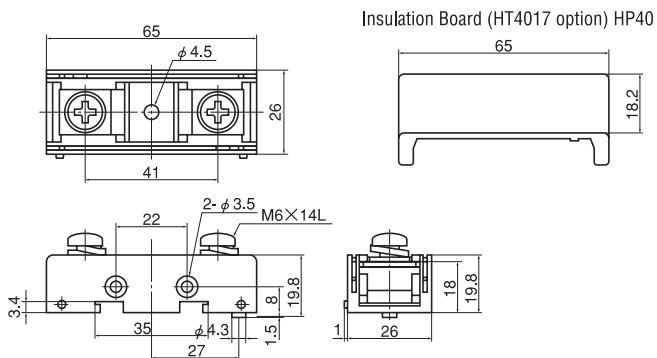

Specifications

Rated voltage	400 V	Applicable fuses	Our product 250FH-20 to 60 250GH-20 to 125*2 350GH-16 to 100*2
Rated amperage	75 A*1		
Applicable wires	Up to 22mm ² (M6)		
Installation	DIN rails and direct installation	Material	PBT
Installing hole size		Option	Partition HP40 (one can be installed on each side.)

*1 Can be left continuously turned on for long durations. *2 Use at voltage and current values lower than rated voltage and rated current of fuse holder.

Specifications/Dimensions

HT6017

HT6017T2

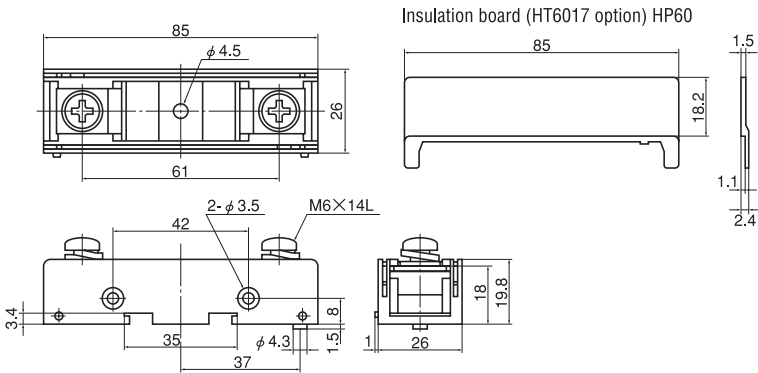

Insulation board (HT6017 option) HP60

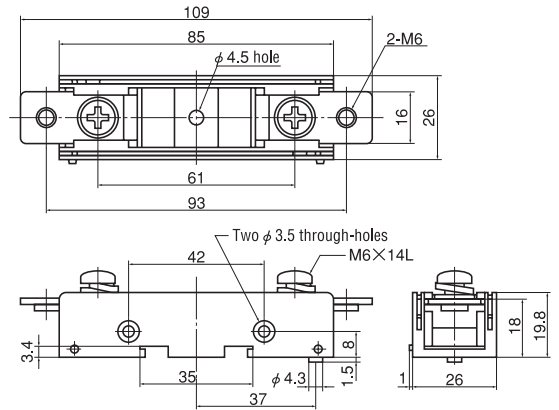

Specifications

Rated voltage	700 V (HT6017T2: 660V)	Applicable fuses	Our product 600FH-20 to 55*2 660GH-16 to 100*2
Rated amperage	75 A*1	Material	PBT
Applicable wires	Up to 22mm ² (M6)	Option	Partition HP60 (one can be installed on each side.)
Installation	DIN rails and direct installation		
Installing hole size			

*1 Can be left continuously turned on for long durations.
*2 Use at voltage and current values lower than rated voltage and rated current of fuse holder.

MICROSWITCHES



Specifications/Dimensions

For GH & GH Series

For SPF Series

AMS-3BT

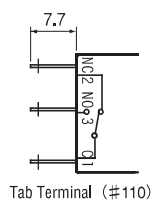

AMS-3B/01B

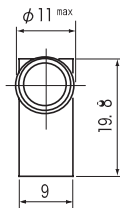
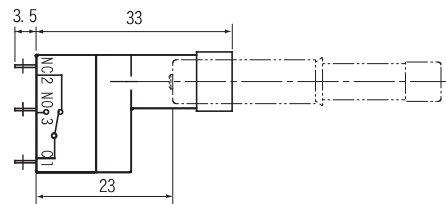

AMS-5VX/01VX

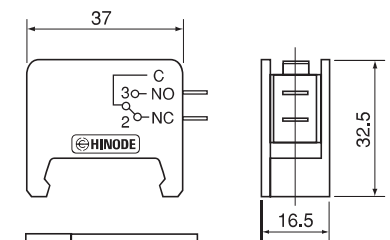

AMS-7B / 7B01

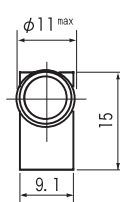
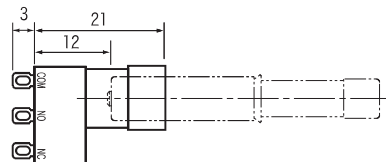
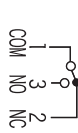

Specifications

Model	Rated Voltage (V)	Resistive Load (A)	Induction Load (A)	Switch Model
AMS-3B Standard Model	AC250	3	3	Omron SS-5GL
	DC30	4	2	
AMS-3BT Tab Terminal	AC250	3	3	Omron SS-5GLT
	DC30	4	2	
AMS-01B Very Low-Current Model	AC125	0.1	—	Omron SS-01GL
	DC30	0.1	—	
AMS-7B Standard Model	AC125	3	2	Omron D2F-D3
	DC30	2	—	
AMS-7B01 Very Low-Current Model	DC30	0.1	—	Omron D2F-01-D3
	DC5	0.1	—	

Model	Rated Voltage (V)	Resistive Load (A)	Induction Load (A)	Switch Model
AMS-5VX Standard Model	AC250	5	4	Omron VX-5-IA3
	DC30	5	4	
	DC125	0.4	0.4	
AMS-01VX Very Low-Current Model	AC250	0.1	—	Omron VX-01-IA3
	DC8	0.1	—	
	DC30	0.1	—	

PROTECT FUSE USER'S GUIDE

Where in the circuit should I use a fuse?

First, consider what you would like to protect with the fuse.

Examples of applying position on the inverter circuit

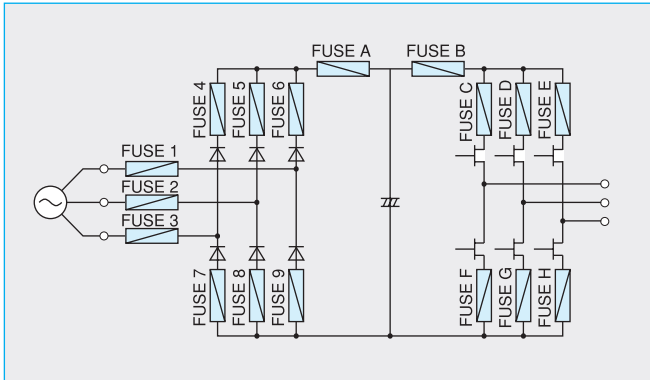

To prevent secondary damage to supplied power

- To protect from condenser short circuit or IGBT short circuit ... Applicable to FUSE A
- To cope with accidents from condenser short circuit, IGBT short circuit, and diode short circuit ... Applicable to FUSE 1 and 3.
- To cope with condenser short circuit, IGBT short circuit, diode short circuit, earth short circuit ... Applicable to FUSE 1, 2, and 3, and also to FUSE 4, 5, 6, 7, 8, and 9.

To prevent diode chips from being damaged

- If you would like to prevent explosion or ignition of chips with fewer fuses:
 - To prevent damage to a chip by adverse DC current ... Applicable to FUSE A.
 - To prevent damage to a chip by supplied power current ... Applicable to FUSE 1 and 3.
 - To prevent both of the above ... Applicable to FUSE A, 1, and 3.
- If you would like to reuse sound chips as well as to prevent explosion or ignition of chips ... Applicable to FUSE 4, 5, 6, 7, 8, and 9.

To prevent explosion and short-circuit mode of IGBT or thyristor chips

- If you would like to protect with fewer fuses ... Applicable to FUSE B.
- If you would like to reuse sound chips (only for thyristors) ... Applicable to FUSE C, D, E, F, G, and H.

For devices from a few kilowatts to tens of kilowatts, fuses are often applied to FUSE 1, 3, and A.

How to select a fuse

Main factors in selection

- Working voltage (AC or DC)
- Normal electric current
- Inrush current
- Ambient temperature
- Breaking current (maximum breaking current and minimum breaking current)
- Durability performance
- Installation structure

Select an appropriate fuse taking these factors into consideration.

Working voltage

Set the rated voltage of the fuse over the voltage of the circuit where the fuse is to be inserted.

Normal electric current

To avoid unnecessary fusing, lower the load factor of the normal electric current according to the rated amperage of the fuse. The main load factors used for our products are as follows:

* The load factor is at the ambient temperature of 25°C.

Model	Load Factor	Constant current and alternating sine wave current	Pulse wave form of inverters / power regulators
250SF/SFK	60% or less	60% or less	50% or less
500SF/SFK			
660CF/KH/KHK			
400KH/KHK	50% or less	50% or less	40% or less
250GH/350GH 660GH			
600SPF 1000SPF	70% or less	70% or less	60% or less
1000GH			
1500SPF			
	60% or less	60% or less	50% or less

Inrush current (when considering fusing I^2t)

The fusing I^2t indicated in this catalog is the energy of the fused electric current in time when the heat that occurred does not radiate from the inner conductor by heat conduction. The fusing I^2t varies according to fuse types. The fusing I^2t has to be considered if the inrush current (surge electric current, start electric current, plunge electric current, and so on) occurs. If the I^2t of the inrush current is higher than the fuse I^2t , it will cause unnecessary fusing. By setting the I^2t of inrush current to less than 25% of the fuse's I^2t , the fuse will withstand the repetitive inrush current over 30,000 times.

Ambient temperature

The fuse characteristics described above assume an ambient temperature of 25°C. At a higher ambient temperature, the fuse works in a hotter state, and therefore its life will be shorter. If the ambient temperature is high, reduce the load factor. (Refer to chart titled "reduction rate by the ambient temperature.").

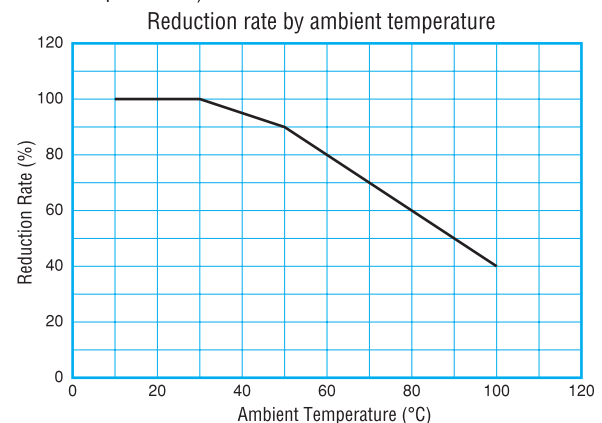

Breaking current

Maximum breaking current

Assume that the current breaking capacity of the fuse is greater than the maximum broken current of the circuit.

Minimum breaking current

Use the fuse with other protection equipment as there may be a possibility of a restriking arc after fusing if an accidental current in the circuit is below the minimum breaking current.

Circuit time constant

When using for a direct-current circuit, use it under the time constant prescribed by the breaking capacity (or reduce the voltage by its circuit time constant).

FOR SAFE USE / PRODUCT WARRANTY

FOR SAFE USE



CAUTION!

- Installation/removal, wiring work, maintenance, and inspection must be done by an expert.
- Do not use under an abnormal environment such as a place with high temperature and/or high humidity, a dusty place, a place filled with corrosive gas, or a place that may be subject to physical vibrations and/or shock.
- Do not expose to any liquids.
- Make sure that the terminal is securely tightened. Using a loose terminal may cause a fire.
- Use a wire suitable for the working voltage and the conduction current. When it is used with incomplete wiring, it may cause a fire.
- Do not dismantle or remodel the product.
- Do not use the fuse if you find any damage or alterations while unpacking.
- Use below the rated voltage of the fuse. If exceeded, a burnout or an explosion may occur.
- Use the fuse such that its current breaking capacity is not exceeded. If exceeded, a burnout or an explosion may occur.
- When using for the following equipment or purposes, consult our business desk and finalize specifications for delivery. Safety and security in design and use are the user's responsibility.
 - Use on equipment or for a purpose that may directly result in injury or death such as medical equipment.
 - Use on a train, an elevator, and so on that may endanger human lives.
 - Use on equipment or use for purposes that may involve a shock or a vibration, such as when loading on a vehicle or a ship.
 - Use on equipment or for purposes that may have a serious effect on society and/or public (e.g., in a traffic system).
 - Use on equipment or use for purposes related to the above.



WARNING

- When using the fuse for a direct-current circuit, use it at a value lower than the time constant corresponding to the breaking capacity (or reduce the voltage by varying the circuit time constant). It may cause a burnout or an explosion if the time constant of the fuse is exceeded.
- When there is a possibility of block-off below the minimum breaking current, take measures such as using other means of protection in addition to the fuse. When no measures are taken, it may cause a burnout or an explosion.
- When the fuse blocks off, the welding arc voltage occurs between the fuse poles, so be sufficiently careful about arrangement of parts around the fuse.
- A fuse protecting a semiconductor becomes hotter than other general parts even under normal conditions. Touching the fuse may cause burns when the equipment is turned on or after an accidental block-off; attach a label to call attention to the high temperature near the fuse installed on the equipment.



DANGER

- Be careful not to touch a fuse by hand when an electric current is flowing; it may cause an electric shock. When installing the product on equipment, make sure that a shock-guard protector is attached to the fuse or a label is put nearby to indicate the danger of electric shock.

PRODUCT WARRANTY

• Period of Warranty

The period of warranty is one year from the date of delivery.

• Scope of Warranty

We will re-deliver the same product or a substitute product promptly in case a product defect causes an inconvenience during the above warranty period. However, the following exceptions apply:

1. When the inconvenience is due to the customer's decision when adopting the product.
2. When an inconvenience occurred that could not be predicted in a performed evaluation test.
3. When the product was exposed to physical, chemical, and/or electrical-engineering-related stress without the manufacturer's consent.
4. When it was difficult to perceive the concerned defect with the level of science and technologies of both the manufacturer and the customer at the time of the product delivery.
5. When the defect is based on directions of the customer who was engaged in its design.
6. When the malfunction is due to a reason not deriving from the supplied products.
7. When the product defects are due to remodeling by someone other than the manufacturer, or when the product defects are caused by violating conditions about the specifications and/or storage that are determined by the manufacturer.
8. When the supplied product is used, without the manufacturer's prior consent, in situations in which the product defects could harm human lives or cause great physical damage to occur.

• Notice about the Warranty

1. Note that compensations are made through the delivery of a replacement or substitute in all cases.
2. When using our fuse for a market where high reliability and safety are required, take precautions in the design of, and security measures for, the applicable device at your own responsibility.
3. If a malfunction or a breakdown of unknown origin causing fusing occurs remove the fuse as-is and return it to our office.
4. For the AMS series, the warranty is also in accordance with the warranty conditions of the microswitch manufacturer as well as those mentioned above. Refer to the warranty of the microswitch manufacturer.

Note that the descriptions in this catalog are subject to change without notice for product improvements or for other reasons.



Founded in 1955

HINODE ELECTRIC CO.,LTD.

1-18-9 Hokima, Adachi-ku, Tokyo 121-0064, JAPAN

URL:<http://www.hinodedenki.co.jp>

Agency

*The specifications are subject to change without notice for product improvements.